

HX220 L

MOTOR		
Hersteller / Modell	Cummins QSB6.7	
Typ	Turboaufgeladener 4-Takt-Dieselmotor mit Ladeluftkühlung	
Nennleistung am Schwungrad	SAE J1995 (brutto)	136 kW (182,6 PS) bei 1950 U/min
	SAE J1349 (netto)	129 kW (173 PS) bei 1950 U/min
	DIN 6271/1 (brutto)	136 kW (185 PS) bei 1950 U/min
	DIN 6271/1 (netto)	129 kW (175 PS) bei 1950 U/min
Höchstdrehmoment	85,7 kgf·m (620 lbf·ft) bei 1500 U/min	
Bohrung x Hub	107 x 124 mm (4.21" x 4.88")	
Hubraum	6700 cc (409 Kubikzoll)	
Batterien	2 x 12 V x 100 Ah	
Anlasser	Denso 24 V - 4,8 kW	
Generator	Denso 24 V - 95 A	

HYDRAULIKSYSTEM

HAUPTPUMPE

Typ	Verstellbare Axialkolbenpumpen in Tandemausführung
Maximaler Durchfluss	2 x 222 l/min
Hilfspumpe für Vorsteuerkreis	Zahnradpumpe

Quererfassendes und kraftstoffsparendes Pumpensystem

HYDRAULIKMOTOREN

Fahren	Axialkolbenmotor mit zwei Geschwindigkeiten mit Bremsventil und Parkbremse
Schwenken	Axialkolbenmotor mit automatischer Bremse

ÜBERDRUCKVENTILEINSTELLUNG

Anbaugerätekreise	350 kgf/cm ² (4980 psi)
Fahren	350 kgf/cm ² (4980 psi)
Leistungsstufe (Ausleger, Löffelstiel, Löffel)	380 kgf/cm ² (5400 psi)
Schwenkkreis	265 kgf/cm ² (3770 psi)
Vorsteuerkreis	40 kgf/cm ² (570 psi)
Serviceventil	Installiert

HYDRAULIKZYLINDER

Zylinder: Bohrung x Hub	Ausleger: Ø 120 x 1290 mm
	Zweiteiliger Ausleger: Ø 160 x 1060 mm
	Löffelstiel: Ø 140 x 1510 mm
	Tiefelöffel: Ø 120 x 1055 mm

ANTRIEBE UND BREMSEN

Antriebsart	Vollhydrostatisch
Antriebsmotor	Axialkolbenmotor, mit Bremse integriert
Untersetzung	Planetenuntersetzungsgetriebe
Max. Zugkraft	20200 kgf (44,530 lbf)
Max. Fahrgeschwindigkeit (Schnell-/Langsamgang)	5,5 km/h (3.41 mph) / 3,6 km/h (2.23 mph)
Steigfähigkeit	35° (70%)
Handbremse	Mehrscheibenausführung, nass

STEUERUNG

Vorsteuerdruckunterstützte Joysticks und Pedale mit abnehmbarem Hebel für nahezu kraft- und ermüdungsfreie Bedienung.

Vorsteuerung	Zwei Joysticks mit einem Sicherheitshebel (links): Schwenken und Löffelstiel (rechts): Ausleger und Tiefelöffel (ISO)
Fahren und Lenken	Zwei Hebel mit Pedalen
Motordrossel	Elektrisch, als Drehregler ausgeführt

SCHWENKWERK

Schwenkmotor	Axialkolbenmotor mit festem Schluckvolumen
Schwenkuntersetzung	Planetenraduntersetzung
Drehkransschmierung	Fettbad
Schwenkbremse	Mehrscheibenausführung, nass
Schwenkgeschwindigkeit	10,8 U/min

SERVICE-FÜLLMENGEN

	Liter	US gal	UK gal
Nachfüllmenge			
Kraftstofftank	400	106	88
Motorkühlmittel	40	10.6	8.8
Motoröl	23	6.1	5.06
Schwenkeinrichtung	6,2	1.64	1.36
Endantrieb (je)	4,5	1.2	1
Hydrauliksystem (einschl. Behälter)	275	72.6	60.5
Hydraulikölbehälter	160	42.3	35.2
DEF/AdBlue®	27	7.1	5.9

UNTERWAGEN

Der X-Mittelrahmen ist eine vollverschweißte Konstruktion mit verstärkten Kastenrahmen für das Laufwerk. Der Unterwagen ist mit geschmierten Rollen, Leiträdern, Kettenspannern mit stoßdämpfenden Federn und Antriebsrädern sowie Raupenkettenspannern mit 2- oder 3-Steg-Bodenplatten ausgerüstet.

Mittelrahmen	X-Rahmen
Unterwagen	Fünfeckiges Kastenprofil
Kettenplatten pro Seite	49 je
Stützrollen pro Seite	2 je
Laufrollen pro Seite	9 je
Kettenführungen pro Seite	2 je

BETRIEBSGEWICHT (CIRCA)

Betriebsgewicht, einschliesslich 5680 mm (18' 8") Ausleger; 2920 mm (9' 7") Löffelstiel; 0,92 m³ (1.20 yd³) Löffel gehäuft nach SAE, Schmiermittel, Kühlmittel, vollem Kraftstofftank, vollem Hydraulikölbehälter und aller Standardausrüstung.

BETRIEBSGEWICHT

Platten	Betriebsgewicht		Bodendruck	
Typ	Breite mm (in)	kg (lb)	kgf/cm ² (psi)	
Dreisteg	600 (24")	HX220 L	22100 (48,720)	0,47 (6,68)
		HX220 L HW	23560 (51,940)	0,50 (7,11)
	700 (28")	HX220 L	22380 (49,340)	0,41 (5,83)
		HX220 L HW	23840 (52,560)	0,44 (6,26)
	800 (32")	HX220 L	22660 (49,960)	0,36 (5,12)
		HX220 L HW	24120 (53,170)	0,39 (5,55)
900 (36")	HX220 L	22940 (50,570)	0,33 (4,69)	
	HX220 L HW	24400 (53,790)	0,35 (4,98)	
Doppelsteg	600 (24")	HX220 L HW	23690 (52,230)	0,50 (7,11)
	700 (28")	HX220 L HW	24040 (53,000)	0,43 (6,11)

HX220 NL

MOTOR		
Hersteller / Modell	Cummins QSB6.7	
Typ	Turboaufgeladener 4-Takt-Dieselmotor mit Ladeluftkühlung	
Nennleistung am Schwungrad	SAE J1995 (brutto)	136 kW (182,6 PS) bei 1950 U/min
	SAE J1349 (netto)	129 kW (173 PS) bei 1950 U/min
	DIN 6271/1 (brutto)	136 kW (185 PS) bei 1950 U/min
	DIN 6271/1 (netto)	129 kW (175 PS) bei 1950 U/min
Höchstdrehmoment	85,7 kgf·m (620 lbf·ft) bei 1500 U/min	
Bohrung x Hub	107 x 124 mm (4.21" x 4.88")	
Hubraum	6700 cc (409 Kubikzoll)	
Batterien	2 x 12 V x 100 Ah	
Anlasser	Denso 24 V - 4,8 kW	
Generator	Denso 24 V - 95 A	

HYDRAULIKSYSTEM

HAUPTPUMPE

Typ	Verstellbare Axialkolbenpumpen in Tandemausführung
Maximaler Durchfluss	2 x 222 l/min
Hilfspumpe für Vorsteuerkreis	Zahnradpumpe

Quererfassendes und kraftstoffsparendes Pumpensystem

HYDRAULIKMOTOREN

Fahren	Axialkolbenmotor mit zwei Geschwindigkeiten mit Bremsventil und Parkbremse
Schwenken	Axialkolbenmotor mit automatischer Bremse

ÜBERDRUCKVENTILEINSTELLUNG

Anbaugerätkreise	350 kgf/cm ² (4980 psi)
Fahren	350 kgf/cm ² (4980 psi)
Leistungsstufe (Ausleger, Löffelstiel, Löffel)	380 kgf/cm ² (5400 psi)
Schwenkkreis	265 kgf/cm ² (3770 psi)
Vorsteuerkreis	40 kgf/cm ² (570 psi)
Serviceventil	Installiert

HYDRAULIKZYLINDER

Zylinder: Bohrung x Hub	Ausleger: Ø 120 x 1290 mm
	Zweiteiliger Ausleger: Ø 160 x 1060 mm
	Löffelstiel: Ø 140 x 1510 mm
	Tiefelöffel: Ø 120 x 1055 mm

ANTRIEBE UND BREMSEN

Antriebsart	Vollhydrostatisch
Antriebsmotor	Axialkolbenmotor, mit Bremse integriert
Untersetzung	Planetenuntersetzungsgetriebe
Max. Zugkraft	20200 kgf (44,530 lbf)
Max. Fahrgeschwindigkeit (Schnell-/Langsamgang)	5,5 km/h (3.41 mph) / 3,6 km/h (2.23 mph)
Steigfähigkeit	35° (70%)
Handbremse	Mehrscheibenausführung, nass

STEUERUNG

Vorsteuerdruckunterstützte Joysticks und Pedale mit abnehmbarem Hebel für nahezu kraft- und ermüdungsfreie Bedienung.

Vorsteuerung	Zwei Joysticks mit einem Sicherheitshebel (links): Schwenken und Löffelstiel (rechts): Ausleger und Tiefelöffel (ISO)
Fahren und Lenken	Zwei Hebel mit Pedalen
Motordrossel	Elektrisch, als Drehregler ausgeführt

SCHWENKWERK

Schwenkmotor	Axialkolbenmotor mit festem Schluckvolumen
Schwenkuntersetzung	Planetenraduntersetzung
Drehkranzschmierung	Fettbad
Schwenkbremse	Mehrscheibenausführung, nass
Schwenkgeschwindigkeit	10,8 U/min

SERVICE-FÜLLMENGEN

Nachfüllmenge	Liter	US gal	UK gal
Kraftstofftank	310	81.9	68.2
Motorkühlmittel	40	10.6	8.8
Motoröl	23,7	6.3	5.2
Schwenkeinrichtung	6,2	1.64	1.36
Endantrieb (je)	4,5	1.2	1
Hydrauliksystem (einschl. Behälter)	340	89.8	74.8
Hydraulikölbehälter	165	43.6	36.3
DEF/AdBlue®	27	7.1	5.9

UNTERWAGEN

Der X-Mittelrahmen ist eine vollverschweißte Konstruktion mit verstärkten Kastenrahmen für das Laufwerk. Der Unterwagen ist mit geschmierten Rollen, Leiträdern, Kettenspannern mit stoßdämpfenden Federn und Antriebsrädern sowie Raupenkettenspannern mit 2- oder 3-Steg-Bodenplatten ausgerüstet.

Mittelrahmen	X-Rahmen
Unterwagen	Fünfeckiges Kastenprofil
Kettenplatten pro Seite	49 je
Stützrollen pro Seite	2 je
Laufrollen pro Seite	9 je
Kettenführungen pro Seite	2 je

BETRIEBSGEWICHT (CIRCA)

Betriebsgewicht, einschliesslich 5650 mm (18' 6") Ausleger; 2920 mm (9' 7") Löffelstiel; 0,87 m³ (1.14 yd³) Löffel gehäuft nach SAE, Schmiermittel, Kühlmittel, vollem Kraftstofftank, vollem Hydraulikölbehälter und aller Standardausrüstung.

BETRIEBSGEWICHT



Platten	Betriebsgewicht		Bodendruck
	Breite mm (in)	kg (lb)	
Dreisteg	500 (20")	HX220 NL 22300 (49,160)	0,57 (8,11)
	600 (24")	HX220 NL 22400 (49,380)	0,48 (6,83)
	700 (28")	HX220 NL 22870 (50,420)	0,42 (5,97)

AUSWAHLHILFE BAGGERLÖFFEL UND SCHACHTKRAFT

HX220 L / NL

HX220 L

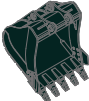
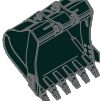
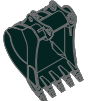
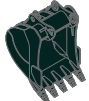
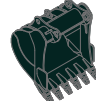
LÖFFEL

						
gehäuft nach SAE m ³ (yd ³)	0,80 (1.05) 0,92 (1.20) 1,10 (1.44) 1,20 (1.57)	1,34 (1.75)	◆ 0,90 (1.18) ◆ 1,05 (1.37)	◆ 0,87 (1.14)	◆ 1,20 (1.57)	★ 0,52 (0.68)

Inhalt m ³ (yd ³)		Breite mm (in)		Gewicht kg (lb)	Empfehlung mm (ft.in)							
					5680 (18' 8") Ausleger				5650 (18' 6") Zweiteiliger Ausleger:			8200 (26' 11") Ausleger
gehäuft nach SAE	gehäuft nach CECE	Ohne Seiten- schneidkanten	Mit Seiten- schneidkanten		2000 (6' 7") Löffelstiel	2400 (7' 10") Löffelstiel	2920 (9' 7") Löffelstiel	3900 (12' 10") Löffelstiel	2000 (6' 7") Löffelstiel	2400 (7' 10") Löffelstiel	2920 (9' 7") Löffelstiel	6300 (20' 8") Löffelstiel
0,80 (1.05)	0,70 (0.92)	1070 (42.1)	1160 (45.7)	770 (1,700)	●	●	●	○	●	●	⊙	-
0,92 (1.20)	0,80 (1.05)	1190 (46.9)	1280 (50.4)	820 (1,810)	●	●	●	○	●	●	⊙	-
1,10 (1.44)	0,96 (1.26)	1375 (54.1)	1465 (57.7)	890 (1,960)	●	●	⊙	○	●	⊙	○	-
1,20 (1.57)	1,05 (1.37)	1390 (54.7)	1480 (58.3)	920 (2,030)	●	⊙	○	-	●	⊙	-	-
1,34 (1.75)	1,17 (1.53)	1525 (60.0)	1615 (63.6)	990 (2,180)	⊙	⊙	○	-	⊙	○	-	-
◆ 0,90 (1.18)	0,79 (1.03)	1210 (47.6)	-	880 (1,940)	●	●	●	○	●	●	⊙	-
◆ 1,05 (1.37)	0,92 (1.20)	1355 (53.3)	-	940 (2,070)	●	●	⊙	○	●	⊙	○	-
◆ 0,87 (1.14)	0,77 (1.01)	1195 (47.0)	-	940 (2,070)	●	●	●	○	●	●	⊙	-
◆ 1,20 (1.57)	1,05 (1.37)	1520 (59.8)	-	1120 (2,470)	⊙	○	-	-	⊙	○	-	-
★ 0,52 (0.68)	0,45 (0.59)	945 (37.2)	1020 (40.2)	460 (1,010)	-	-	-	-	-	-	-	⊙

- ◆ Tieflöffel für hohe Beanspruchung
- ◆ Felslöffel für hohe Beanspruchung
- ★ Tieflöffel für Long Reach

- : Für Material mit einer Dichte von maximal 2000 kg / m³ (3370 lb/ yd³)
- ⊙ : Für Material mit einer Dichte von maximal 1600 kg / m³ (2700 lb/ yd³)
- : Für Material mit einer Dichte von maximal 1100 kg / m³ (1850 lb/ yd³)

ANBAUGERÄT

Ausleger und Löffelstiel sind als verschweißtes, spannungsarmes Kastenprofil ausgeführt. Erhältlich: Ausleger in 5,68 m (18' 8") und 8,2 m (26' 11") und Zweiteiliger Ausleger in 5,65 m (18' 6") und Löffelstiel in 2,0 m (6' 7"); 2,4 m (7' 10"); 2,92 m (9' 7"); 3,9 m (12' 10") und 6,3 m (20' 8").

SCHACHTKRAFT

Ausleger	Länge	mm (ft.in)	Ausleger 5680 (18' 8")				Zweiteiliger Ausleger 5650 (18' 6")			8200 (26' 11")	Anmer- kungen:
			1950 (4,300)				2600 (5,730)			2350 (5,180)	
Löffelstiel	Länge	mm (ft.in)	2000 (6' 7")	2400 (7' 10")	2920 (9' 7")	3900 (12' 10")	2000 (6' 7")	2400 (7' 10")	2920 (9' 7")	6300 (20' 8")	
			Gewicht kg (lb)								
Tieflöffel Losbrech- kraft	SAE	kN	133,4 [144,8]	133,4 [144,8]	133,4 [144,8]	133,4 [144,8]	133,4 [144,8]	133,4 [144,8]	133,4 [144,8]	72,6	
		kgf	13600 [14770]	13600 [14770]	13600 [14770]	13600 [14770]	13600 [14770]	13600 [14770]	13600 [14770]	7400	
		lbf	29980 [32550]	29980 [32550]	29980 [32550]	29980 [32550]	29980 [32550]	29980 [32550]	29980 [32550]	16310	
	ISO	kN	152,0 [165,0]	152,0 [165,0]	152,0 [165,0]	152,0 [165,0]	152,0 [165,0]	152,0 [165,0]	152,0 [165,0]	83,4	
		kgf	15500 [16830]	15500 [16830]	15500 [16830]	15500 [16830]	15500 [16830]	15500 [16830]	15500 [16830]	8500	
		lbf	34170 [37100]	34170 [37100]	34170 [37100]	34170 [37100]	34170 [37100]	34170 [37100]	34170 [37100]	18740	
Tieflöf- felstiel Reißkraft	SAE	kN	144,2 [156,5]	119,6 [129,9]	102,0 [110,7]	84,3 [91,6]	144,2 [156,5]	119,6 [129,9]	102,0 [110,7]	49,0	
		kgf	14700 [15960]	12200 [13250]	10400 [11290]	8600 [9340]	14700 [15960]	12200 [13250]	10400 [11290]	5000	
		lbf	32410 [35190]	26900 [29210]	22930 [24900]	18960 [20590]	32410 [35190]	26900 [29210]	22930 [24900]	11020	
	ISO	kN	151,0 [164,0]	125,5 [136,3]	106,9 [116,1]	87,3 [94,8]	151,0 [164,0]	125,5 [136,3]	106,9 [116,1]	50,0	
		kgf	15400 [16720]	12800 [13900]	10900 [11830]	8900 [9660]	15400 [16720]	12800 [13900]	10900 [11830]	5100	
		lbf	33950 [36860]	28220 [30640]	24030 [26090]	19620 [21300]	33950 [36860]	28220 [30640]	24030 [26090]	11240	



Hinweis : Auslegergewicht inklusive Stielzylinder, Verrohrung und Bolzen.
Stielgewicht inklusive Löffelzylinder, Verbindungsstangen und Bolzen.

AUSWAHLHILFE BAGGERLÖFFEL UND SCHACHTKRAFT

HX220 L / NL

HX220 NL

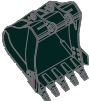
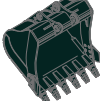
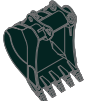
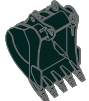
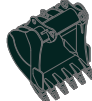
LÖFFEL

						
gehäuft nach SAE m ³ (yd ³)	0,80 (1.05) 0,92 (1.20) 1,10 (1.44) 1,20 (1.57)	1,34 (1.75)	◆ 0,90 (1.18) ◆ 1,05 (1.37)	◆ 0,87 (1.14)	◆ 1,20 (1.57)	★ 0,52 (0.68)

Inhalt m ³ (yd ³)		Breite mm (in)		Gewicht kg (lb)	Empfehlung mm (ft.in)					
					5650 (18' 6") Ausleger			5650 (18' 6") Zweiteiliger Ausleger		
gehäuft nach SAE	gehäuft nach CECE	Ohne Seiten- schneidkanten	Mit Seiten- schneidkanten		2000 (6' 7") Löffelstiel	2400 (7' 10") Löffelstiel	2920 (9' 7") Löffelstiel	2000 (6' 7") Löffelstiel	2400 (7' 10") Löffelstiel	2920 (9' 7") Löffelstiel
0,80 (1.05)	0,70 (0.92)	1070 (42.1)	1160 (45.7)	770 (1,700)	●	●	●	●	●	○
0,92 (1.20)	0,80 (1.05)	1190 (46.9)	1280 (50.4)	820 (1,810)	●	●	●	●	●	○
1,10 (1.44)	0,96 (1.26)	1375 (54.1)	1465 (57.7)	890 (1,960)	●	●	○	●	○	○
1,20 (1.57)	1,05 (1.37)	1390 (54.7)	1480 (58.3)	920 (2,030)	●	○	○	●	○	-
1,34 (1.75)	1,17 (1.53)	1525 (60.0)	1615 (63.6)	990 (2,180)	○	○	○	○	○	-
◆ 0,90 (1.18)	0,79 (1.03)	1210 (47.6)	-	880 (1,940)	●	●	●	●	●	○
◆ 1,05 (1.37)	0,92 (1.20)	1355 (53.3)	-	940 (2,070)	●	●	○	●	○	○
◆ 0,87 (1.14)	0,77 (1.01)	1195 (47.0)	-	940 (2,070)	●	●	●	●	●	○
◆ 1,20 (1.57)	1,05 (1.37)	1520 (59.8)	-	1120 (2,470)	○	○	-	○	○	-
★ 0,52 (0.68)	0,45 (0.59)	945 (37.2)	1020 (40.2)	460 (1,010)	-	-	-	-	-	-

- ◆ Tieflöffel für hohe Beanspruchung
- ◆ Felslöffel für hohe Beanspruchung
- ★ Tieflöffel für Long Reach

- : Für Material mit einer Dichte von maximal 2000 kg / m³ (3370 lb/ yd³)
- : Für Material mit einer Dichte von maximal 1600 kg / m³ (2700 lb/ yd³)
- : Für Material mit einer Dichte von maximal 1100 kg / m³ (1850 lb/ yd³)

ANBAUGERÄT

Ausleger und Löffelstiel sind als verschweißtes, spannungsarmes Kastenprofil ausgeführt.

Erhältlich: Ausleger in 5,65 m (18' 6") und Zweiteiliger Ausleger in 5,65 m (18' 6") und Löffelstiel in 2,0 m (6' 7"); 2,4 m (7' 10") und 2,92 m (9' 7").

SCHACHTKRAFT

Ausleger	Länge	mm (ft.in)	Ausleger 5650 (18' 6")				Zweiteiliger Ausleger 5650 (18' 6")			Anmer- kungen:
	Gewicht	kg (lb)	1950 (4,300)						2600 (5,730)	
Löffelstiel	Länge	mm (ft.in)	2000 (6' 7")	2400 (7' 10")	2920 (9' 7")	3900 (12' 10")	2000 (6' 7")	2400 (7' 10")	2920 (9' 7")	[]: Leistungs- stufe
	Gewicht	kg (lb)	975 (2,150)	1045 (2,300)	1095 (2,410)	1295 (2,850)	975 (2,150)	1045 (2,300)	1095 (2,410)	
Tieflöffel Losbrech- kraft	SAE	kN	133,4 [144,8]	133,4 [144,8]	133,4 [144,8]	133,4 [144,8]	133,4 [144,8]	133,4 [144,8]	133,4 [144,8]	
		kgf	13600 [14770]	13600 [14770]	13600 [14770]	13600 [14770]	13600 [14770]	13600 [14770]	13600 [14770]	
		lbf	29980 [32550]	29980 [32550]	29980 [32550]	29980 [32550]	29980 [32550]	29980 [32550]	29980 [32550]	
	ISO	kN	152,0 [165,0]	152,0 [165,0]	152,0 [165,0]	152,0 [165,0]	152,0 [165,0]	152,0 [165,0]	152,0 [165,0]	
		kgf	15500 [16830]	15500 [16830]	15500 [16830]	15500 [16830]	15500 [16830]	15500 [16830]	15500 [16830]	
		lbf	34170 [37100]	34170 [37100]	34170 [37100]	34170 [37100]	34170 [37100]	34170 [37100]	34170 [37100]	
Tieflöf- felstiel Reißkraft	SAE	kN	144,2 [156,5]	119,6 [129,9]	102,0 [110,7]	84,3 [91,6]	144,2 [156,5]	119,6 [129,9]	102,0 [110,7]	
		kgf	14700 [15960]	12200 [13250]	10400 [11290]	8600 [9340]	14700 [15960]	12200 [13250]	10400 [11290]	
		lbf	32410 [35190]	26900 [29210]	22930 [24900]	18960 [20590]	32410 [35190]	26900 [29210]	22930 [24900]	
	ISO	kN	151,0 [164,0]	125,5 [136,3]	106,9 [116,1]	87,3 [94,8]	151,0 [164,0]	125,5 [136,3]	106,9 [116,1]	
		kgf	15400 [16720]	12800 [13900]	10900 [11830]	8900 [9660]	15400 [16720]	12800 [13900]	10900 [11830]	
		lbf	33950 [36860]	28220 [30640]	24030 [26090]	19620 [21300]	33950 [36860]	28220 [30640]	24030 [26090]	

Hinweis : Auslegergewicht inklusive Stielzylinder, Verrohrung und Bolzen.

Stielgewicht inklusive Löffelzylinder, Verbindungsstangen und Bolzen.

MASSE UND ARBEITSBEREICH

HX220 L / NL

ABMESSUNGEN HX220 L

Ausleger in 5,68 m (18' 8") und Löffelstiel in 2,0 m (6' 7"); 2,4 m (7' 10"); 2,92 m (9' 7") und 3,9 m (12' 10")

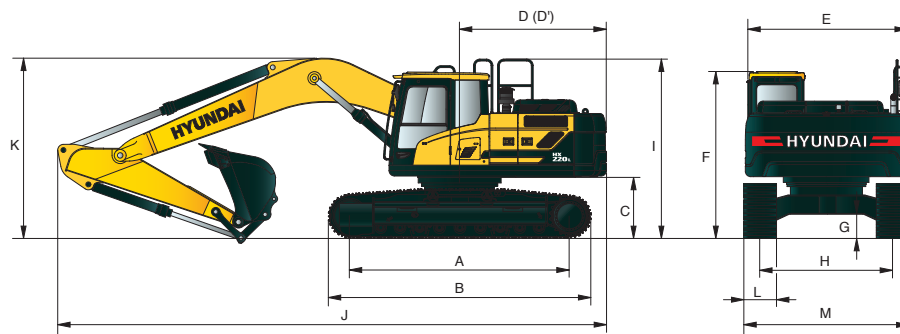

Einheit : mm (ft-in)

A	Aufstandslänge	3650 (12' 0")
B	Gesamtlänge der Raupe	4404 (14' 4")
C	Bodenfreiheit des Heckgegengewichts	1060 (3' 6")
D	Heckschwenkradius	2890 (9' 5")
D'	Hecklänge	2770 (9' 1")
E	Gesamtbreite des Oberwagens	2740 (9' 0")
F	Gesamthöhe der Kabine	3000 (9' 8")
G	Mindest-Bodenfreiheit	480 (1' 7")
H	Spurweite	2390 (7' 10")
I	Gesamthöhe des Schutzgelanders	3210 (10' 5")

Auslegerlänge	5680 (18' 8")			
Löffelstiellänge	2000 (6' 7")	2400 (7' 10")	2920 (9' 7")	3900 (12' 10")
J Gesamtlänge	9650 (31' 8")	9570 (31' 5")	9530 (31' 3")	9520 (31' 3")
K Gesamthöhe des Auslegers	3200 (10' 6")	3110 (10' 2")	3030 (9' 11")	3480 (11' 5")
L Breite der Bodenplatten	600 (24")	700 (28")	800 (32")	900 (36")
M Gesamtbreite	2990 (9' 10")	3090 (10' 2")	3190 (10' 6")	3290 (10' 10")

ARBEITSBEREICH HX220 L

Einheit : mm (ft-in)

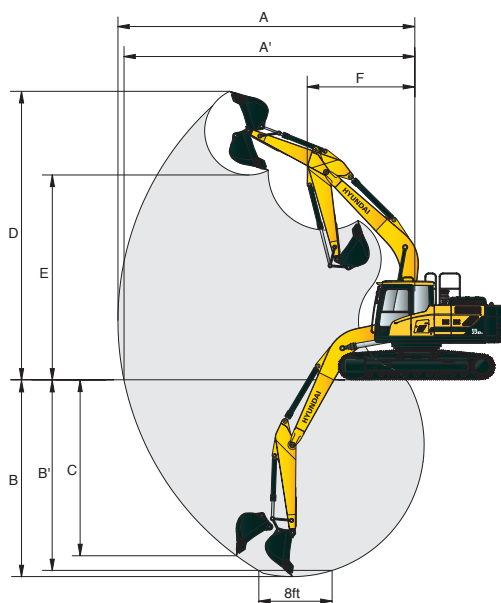

Auslegerlänge	5680 (18' 8")			
Löffelstiellänge	2000 (6' 7")	2400 (7' 10")	2920 (9' 7")	3900 (12' 10")
A Max. Schachtweite	9140 (30' 0")	9500 (31' 2")	9980 (32' 9")	10910 (35' 10")
A' Max. Schachtweite am Boden	8960 (29' 5")	9330 (30' 7")	9820 (32' 3")	10770 (35' 4")
B Max. Schachttiefe	5820 (19' 1")	6220 (20' 5")	6730 (22' 1")	7720 (25' 4")
B' Max. Schachttiefe (auf ca. 2,40 m)	5580 (18' 4")	6010 (19' 9")	6560 (21' 6")	7580 (24' 10")
C Max. vertikale Abstechtiefte	5280 (17' 4")	5720 (18' 9")	6280 (20' 7")	7240 (23' 9")
D Max. Einstechhöhe	9140 (30' 0")	9340 (30' 8")	9600 (31' 6")	10110 (33' 2")
E Max. Ladehöhe	6330 (20' 9")	6520 (21' 5")	6780 (22' 3")	7290 (23' 11")
F Min. Frontschwenkradius	3750 (12' 4")	3740 (12' 3")	3670 (12' 0")	3700 (12' 2")

MASSE UND ARBEITSBEREICH

HX220 L / NL

ABMESSUNGEN HX220 L ZWEITEILIGER AUSLEGER

Zweiteiliger Ausleger in 5,65 m (18' 6") und Löffelstiel in 2,0 m (6' 7"); 2,4 m (7' 10") und 2,92 m (9' 7")

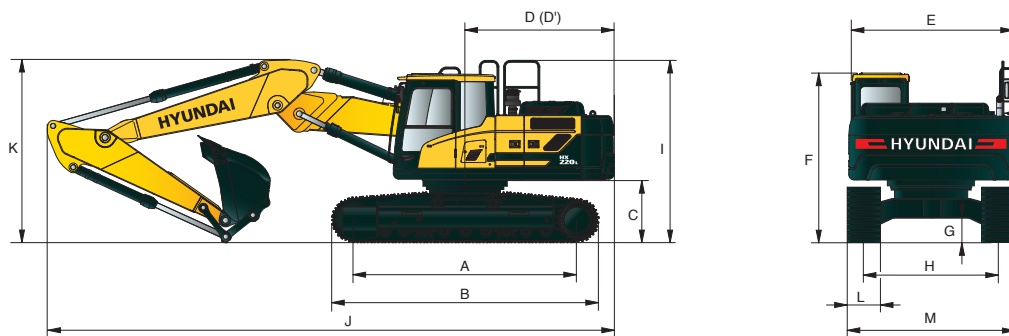

Einheit : mm (ft-in)

A	Aufstandslänge	3650 (12' 0")
B	Gesamtlänge der Raupe	4404 (14' 4")
C	Bodenfreiheit des Heckgegengewichts	1060 (3' 6")
D	Heckschwenkradius	2890 (9' 5")
D'	Hecklänge	2770 (9' 1")
E	Gesamtbreite des Oberwagens	2740 (9' 0")
F	Gesamthöhe der Kabine	3000 (9' 8")
G	Mindest-Bodenfreiheit	480 (1' 7")
H	Spurweite	2390 (7' 10")
I	Gesamthöhe des Schutzgeländers	3210 (10' 5")

Auslegerlänge	5650 (18' 6") Zweiteiliger Ausleger			
Löffelstiellänge	2000 (6' 7")	2400 (7' 10")	2920 (9' 7")	
J Gesamtlänge	9650 (31' 8")	9570 (31' 5")	9530 (31' 3")	
K Gesamthöhe des Auslegers	3200 (10' 6")	3110 (10' 2")	3030 (9' 11")	
L Breite der Bodenplatten	600 (24")	700 (28")	800 (32")	900 (36")
M Gesamtbreite	2990 (9' 10")	3090 (10' 2")	3190 (10' 6")	3290 (10' 10")

ARBEITSBEREICH HX220 L ZWEITEILIGER AUSLEGER

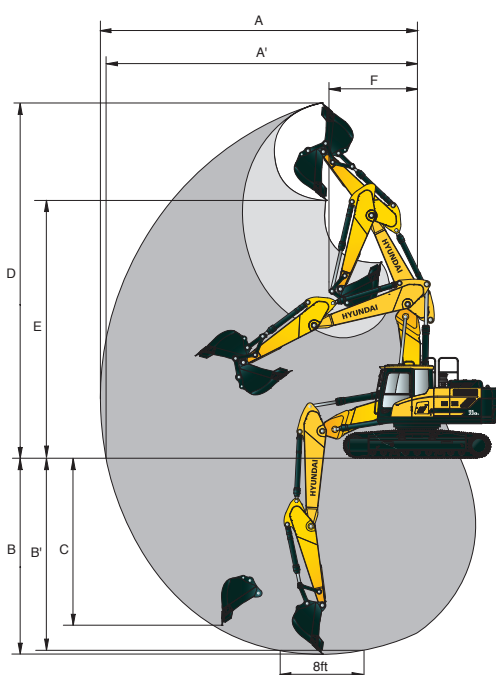

Einheit : mm (ft-in)

Auslegerlänge	5650 (18' 6") Zweiteiliger Ausleger		
Löffelstiellänge	2000 (6' 7")	2400 (7' 10")	2920 (9' 7")
A Max. Schachtweite	9120 (29' 11")	9530 (31' 3")	10020 (32' 10")
A' Max. Schachtweite am Boden	8950 (29' 4")	9360 (30' 8")	9860 (32' 4")
B Max. Schachttiefe	5820 (19' 1")	5880 (19' 3")	6400 (21' 0")
B' Max. Schachttiefe (auf ca. 2,40 m)	5480 (18' 0")	5770 (18' 11")	6290 (20' 8")
C Max. vertikale Abstechtiefe	5360 (17' 7")	5020 (16' 6")	5560 (18' 3")
D Max. Einstechhöhe	10310 (33' 10")	10670 (35' 0")	11090 (36' 5")
E Max. Ladehöhe	7390 (24' 3")	7750 (25' 5")	8160 (26' 9")
F Min. Frontschwenkradius	2870 (9' 5")	2660 (8' 9")	2530 (8' 4")

MASSE UND ARBEITSBEREICH

HX220 L/NL

ABMESSUNGEN HX220 L LONG REACH

Ausleger in 8,2 m (26' 11") und Löffelstiel in 6,3 m (20' 8")

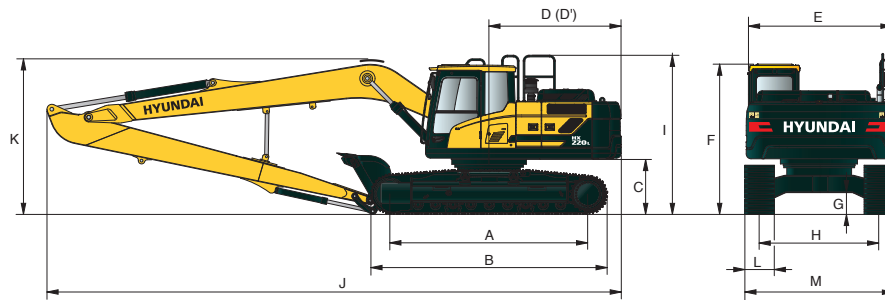

Einheit : mm (ft-in)

A	Aufstandslänge	3650 (12' 0")
B	Gesamtlänge der Raupe	4404 (14' 4")
C	Bodenfreiheit des Heckgegengewichts	1060 (3' 6")
D	Heckschwenkradius	2890 (9' 5")
D'	Hecklänge	2770 (9' 1")
E	Gesamtbreite des Oberwagens	2740 (9' 0")
F	Gesamthöhe der Kabine	3000 (9' 8")
G	Mindest-Bodenfreiheit	480 (1' 7")
H	Spurweite	2390 (7' 10")
I	Gesamthöhe des Schutzgeländers	3210 (10' 5")

	Auslegerlänge	8200 (26' 11")
	Löffelstiellänge	6300 (20' 8")
J	Gesamtlänge	12030 (39' 6")
K	Gesamthöhe des Auslegers	3280 (10' 9")
L	Breite der Bodenplatten	800 (32")
M	Gesamtbreite	3190 (10' 6")

ARBEITSBEREICH HX220 L LONG REACH

Einheit : mm (ft-in)

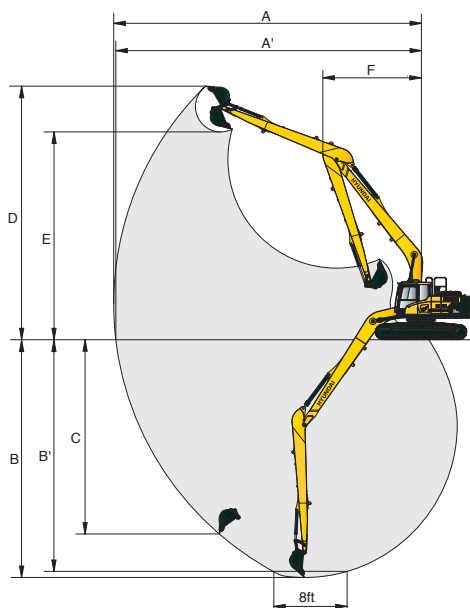

	Auslegerlänge	8200 (26' 11")
	Löffelstiellänge	6300 (20' 8")
A	Max. Schachtweite	15220 (50' 0")
A'	Max. Schachtweite am Boden	15120 (49' 7")
B	Max. Schachttiefe	11760 (38' 7")
B'	Max. Schachttiefe (auf ca. 2,40 m)	11650 (38' 3")
C	Max. vertikale Abstechtiefe	9610 (31' 6")
D	Max. Einstechhöhe	12550 (41' 2")
E	Max. Ladehöhe	10280 (33' 8")
F	Min. Frontschwenkradius	4870 (16' 0")

MASSE UND ARBEITSBEREICH

HX220 L/NL

ABMESSUNGEN HX220 L HIGH WALKER

Ausleger in 5,68 m (18' 8") und Löffelstiel in 2,0 m (6' 7"); 2,4 m (7' 10") und 2,92 m (9' 7")

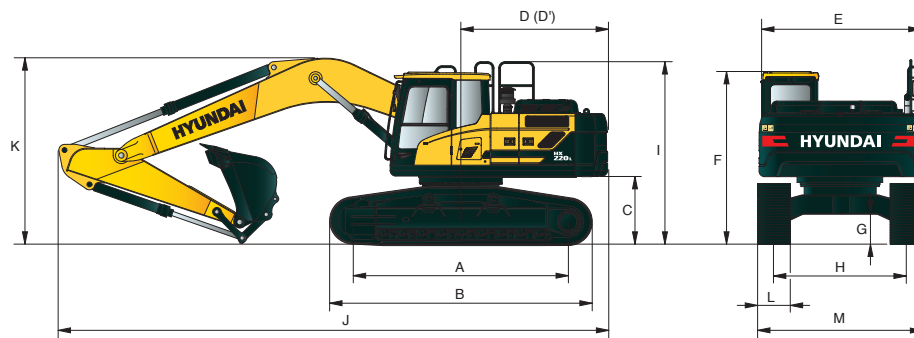

Einheit : mm (ft-in)

A	Aufstandslänge	3650 (12' 0")
B	Gesamtlänge der Raupe	4404 (14' 4")
C	Bodenfreiheit des Heckgegengewichts	1260 (4' 1")
D	Heckschwenkradius	2890 (9' 5")
D'	Hecklänge	2770 (9' 1")
E	Gesamtbreite des Oberwagens	2740 (9' 0")
F	Gesamthöhe der Kabine	3200 (10' 5")
G	Mindest-Bodenfreiheit	660 (2' 2")
H	Spurweite	2795 (9' 2")
I	Gesamthöhe des Schutzgelanders	3410 (11' 2")

Auslegerlänge	5680 (18' 8")					
Löffelstiellänge	2000 (6' 7")	2400 (7' 10")	2920 (9' 7")	3900 (12' 10")		
J Gesamtlänge	9650 (31' 8")	9550 (31' 4")	9470 (31' 1")	9560 (31' 4")		
K Gesamthöhe des Auslegers	3290 (10' 10")	3170 (10' 5")	3060 (10' 0")	3450 (11' 4")		
L Bodenplatten	Typ	Dreisteg			Doppelsteg	
	Breite	600 (24")	700 (28")	800 (32")	900 (36")	600 (24")
M Gesamtbreite	3395 (11' 2")	3495 (11' 6")	3595 (11' 10")	3695 (12' 2")	3395 (11' 2")	3495 (11' 6")

ARBEITSBEREICH HX220 L HIGH WALKER

Einheit : mm (ft-in)

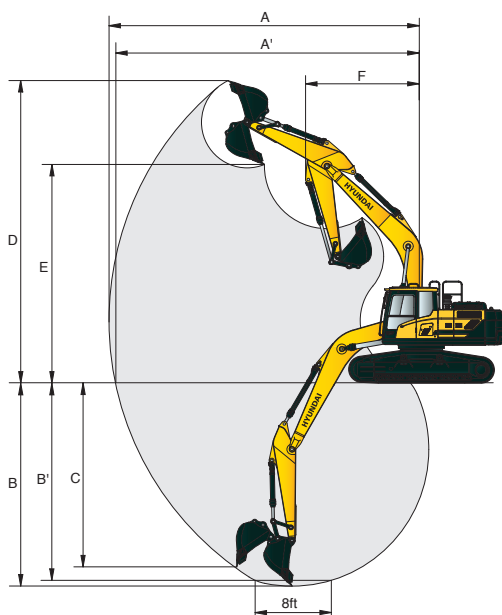

Auslegerlänge	5680 (18' 8")			
Löffelstiellänge	2000 (6' 7")	2400 (7' 10")	2920 (9' 7")	3900 (12' 10")
A Max. Schachtweite	9140 (30' 0")	9500 (31' 2")	9980 (32' 9")	10910 (35' 10")
A' Max. Schachtweite am Boden	8920 (29' 3")	9290 (30' 6")	9820 (32' 3")	10730 (35' 2")
B Max. Schachttiefe	5630 (18' 6")	6010 (19' 9")	6550 (21' 6")	7530 (24' 8")
B' Max. Schachttiefe (auf ca. 2,40 m)	5390 (17' 8")	5820 (19' 1")	6380 (20' 11")	7390 (24' 3")
C Max. vertikale Abstechtiefte	5090 (16' 8")	5630 (18' 6")	6100 (20' 0")	7050 (23' 1")
D Max. Einstechhöhe	9330 (30' 7")	9530 (31' 3")	9780 (32' 1")	10300 (33' 9")
E Max. Ladehöhe	6520 (21' 5")	6710 (22' 0")	6960 (22' 10")	7480 (24' 6")
F Min. Frontschwenkradius	3750 (12' 4")	3740 (12' 3")	3670 (12' 0")	3700 (12' 2")

MASSE UND ARBEITSBEREICH

HX220 L/NL

ABMESSUNGEN HX220 NL

Ausleger in 5,65 m (18' 6") und Löffelstiel in 2,0 m (6' 7"); 2,4 m (7' 10") und 2,92 m (9' 7")

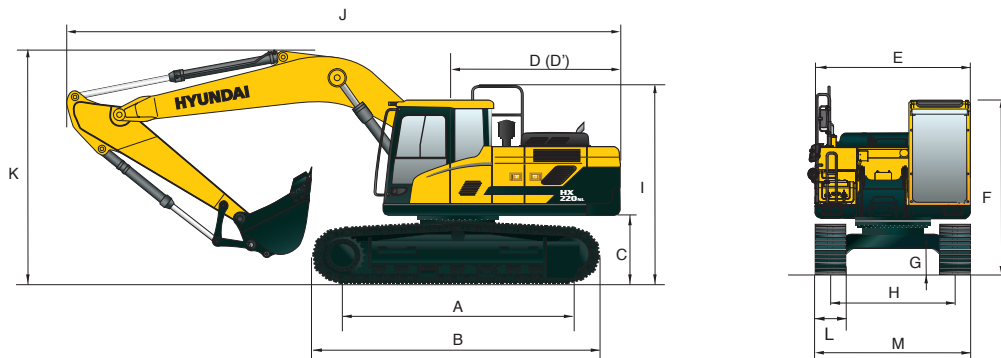

Einheit : mm (ft-in)

A	Aufstandslänge	3650 (12' 0")
B	Gesamtlänge der Raupe	4404 (14' 4")
C	Bodenfreiheit des Heckgegengewichts	1060 (3' 6")
D	Heckschwenkradius	2850 (9' 4")
D'	Hecklänge	2770 (9' 1")
E	Gesamtbreite des Oberwagens	2530 (8' 4")
F	Gesamthöhe der Kabine	3000 (9' 8")
G	Mindest-Bodenfreiheit	480 (1' 7")
H	Spurweite	2000 (6' 7")
I	Gesamthöhe des Schutzgeländers	3210 (10' 5")

Auslegerlänge	5650 (18' 6")		
Löffelstiellänge	2000 (6' 7")	2400 (7' 10")	2920 (9' 7")
J Gesamtlänge	9650 (31' 8")	9570 (31' 5")	9510 (31' 23")
K Gesamthöhe des Auslegers	3250 (10' 8")	3170 (10' 5")	3100 (10' 2")
L Breite der Bodenplatten	500 (20")	600 (24")	700 (28")
M Gesamtbreite	2500 (8' 2")	2600 (8' 6")	2700 (8' 10")

ARBEITSBEREICH HX220 NL

Einheit : mm (ft-in)

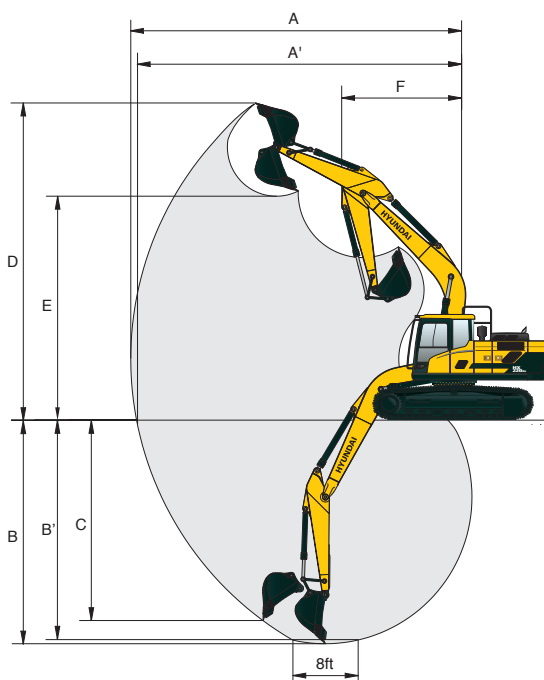

Auslegerlänge	5650 (18' 68")		
Löffelstiellänge	2000 (6' 7")	2400 (7' 10")	2920 (9' 7")
A Max. Schachtweite	9140 (30' 0")	9500 (31' 2")	9960 (32' 8")
A' Max. Schachtweite am Boden	8960 (29' 5")	9340 (30' 8")	9800 (32' 2")
B Max. Schachttiefe	5750 (18' 10")	6150 (20' 2")	6640 (21' 9")
B' Max. Schachttiefe (auf ca. 2,40 m)	5520 (18' 1")	5950 (19' 6")	6470 (21' 36")
C Max. vertikale Abstechtiefe	5320 (17' 5")	5780 (19' 9")	6250 (20' 6")
D Max. Einstechhöhe	9270 (30' 5")	9500 (31' 2")	9740 (31' 11")
E Max. Ladehöhe	6450 (21' 2")	6660 (21' 10")	6900 (22' 8")
F Min. Frontschwenkradius	3710 (12' 2")	3630 (11' 11")	3580 (11' 9")

MASSE UND ARBEITSBEREICH

HX220 L/NL

ABMESSUNGEN HX220 NL ZWEIFTEILIGER AUSLEGER

Zweiteiliger Ausleger in 5,65 m (18' 6") und Löffelstiel in 2,0 m (6' 7"); 2,4 m (7' 10") und 2,92 m (9' 7")

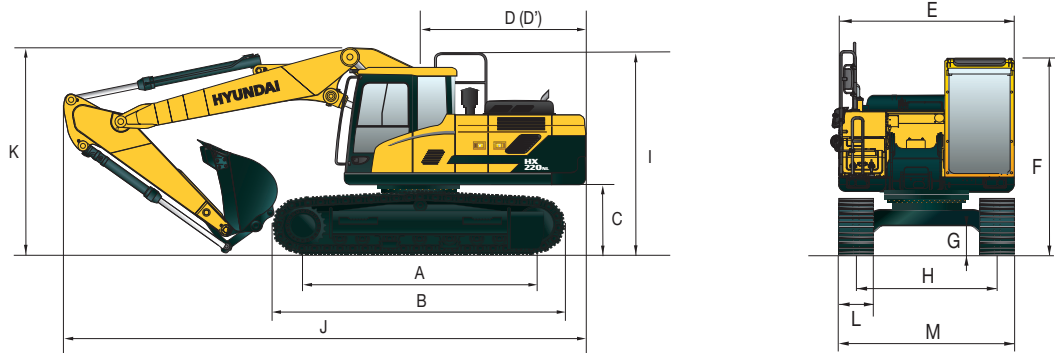

Einheit : mm (ft-in)

A	Aufstandslänge	3650 (12' 0")
B	Gesamtlänge der Raupe	4404 (14' 4")
C	Bodenfreiheit des Heckgegengewichts	1060 (3' 6")
D	Heckschwenkradius	2850 (9' 4")
D'	Hecklänge	2770 (9' 1")
E	Gesamtbreite des Oberwagens	2530 (8' 4")
F	Gesamthöhe der Kabine	3000 (9' 8")
G	Mindest-Bodenfreiheit	480 (1' 7")
H	Spurweite	2000 (6' 7")
I	Gesamthöhe des Schutzgelanders	3210 (10' 5")



Auslegerlänge	5650 (18' 6") Zweiteiliger Ausleger		
Löffelstiellänge	2000 (6' 7")	2400 (7' 10")	2920 (9' 7")
J Gesamtlänge	9650 (31' 8")	9570 (31' 5")	9520 (31' 2")
K Gesamthöhe des Auslegers	3200 (10' 6")	3000 (9' 10")	3030 (9' 11")
L Breite der Bodenplatten	500 (20")	600 (24")	700 (28")
M Gesamtbreite	2500 (8' 2")	2600 (8' 6")	2700 (8' 10")

ARBEITSBEREICH HX220 NL ZWEIFTEILIGER AUSLEGER

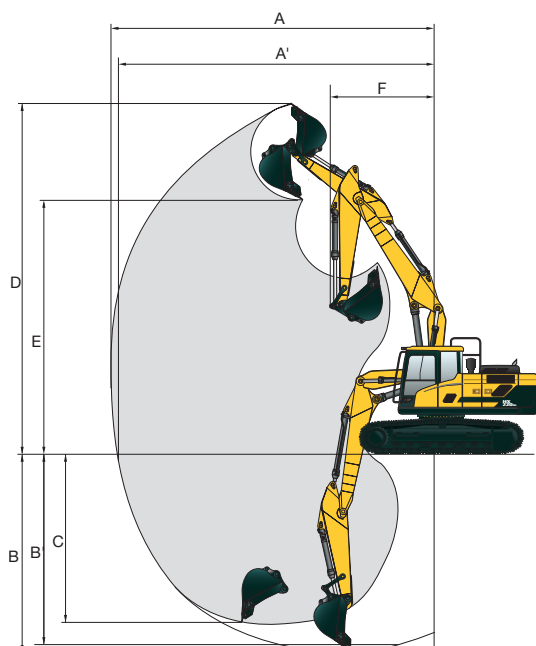
Einheit : mm (ft-in)













Auslegerlänge	5650 (18' 6") Zweiteiliger Ausleger		
Löffelstiellänge	2000 (6' 7")	2400 (7' 10")	2920 (9' 7")
A Max. Schachtweite	9120 (29' 11")	9530 (31' 3")	10020 (32' 10")
A' Max. Schachtweite am Boden	8940 (29' 4")	9360 (30' 9")	9860 (32' 4")
B Max. Schachttiefe	5480 (18' 0")	5890 (19' 4")	6400 (21' 0")
B' Max. Schachttiefe (auf ca. 2,40 m)	5360 (17' 7")	5770 (18' 11")	6300 (20' 8")
C Max. vertikale Abstechtiefte	4560 (15' 0")	4990 (16' 4")	5530 (18' 2")
D Max. Einstechhöhe	10300 (33' 10")	10670 (35' 0")	11080 (36' 4")
E Max. Ladehöhe	7390 (24' 3")	7740 (25' 5")	8160 (26' 9")
F Min. Frontschwenkradius	2870 (9' 5")	2670 (8' 9")	2530 (8' 4")











 Lastradius Frontauslage  Lastradius Seitenauslage bzw. 360 Grad

HX220 L

5,68 m (18' 8") Ausleger; 2,00 m (6' 7") Löffelstiel; 0,92 m³ Löffel (nach SAE gehäuft); 600 mm (24") 3-Steg-Bodenplatten.



Lasthöhe m (ft)	Lastradius								Max. Reichweite		
	3.0 m (10 ft)		4.5 m (15 ft)		6.0 m (20 ft)		7.5 m (25 ft)		Volumen	Reichweite	
											m (ft)
7.5 m (25 ft)	kg								*3970	*3970	6.65
	lb								*8750	*8750	(21.8)
6.0 m (20 ft)	kg				*4400	*4400			*4020	3030	7.78
	lb				*9700	*9700			*8860	6680	(25.5)
4.5 m (15 ft)	kg		*5690	*5690	*4820	4640			*4140	2530	8.43
	lb		*12540	*12540	*10630	10230			*9130	5580	(27.7)
3.0 m (10 ft)	kg		*7420	6860	*5570	4370	*4780	3000	4050	2300	8.74
	lb		*16360	15120	*12280	9630	*10540	6610	8930	5070	(28.7)
1.5 m (5 ft)	kg		*8940	6340	*6340	4120	5080	2880	3990	2250	8.73
	lb		*19710	13980	*13980	9080	11200	6350	8800	4960	(28.6)
Boden- niveau	kg		*9640	6110	*6860	3960	4990	2810	4210	2370	8.42
	lb		*21250	13470	*15120	8730	11000	6190	9280	5220	(27.6)
-1.5 m (-5 ft)	kg	*13940	12320	*9580	6090	*6950	3910		4830	2750	7.76
	lb	*30730	27160	*21120	13430	*15320	8620		10650	6060	(25.5)
-3.0 m (-10 ft)	kg	*12450	*12450	*8770	6200	*6310	4000		*4800	3650	6.61
	lb	*27450	*27450	*19330	13670	*13910	8820		*10580	8050	(21.7)
-4.5 m (-15 ft)	kg	*9410	*9410								
	lb	*20750	*20750								

5,68 m (18' 8") Ausleger; 2,40 m (7' 10") Löffelstiel; 0,92 m³ Löffel (nach SAE gehäuft); 600 mm (24") 3-Steg-Bodenplatten.

Lasthöhe m (ft)	Lastradius								Max. Reichweite				
	1.5 m (5 ft)		3.0 m (10 ft)		4.5 m (15 ft)		6.0 m (20 ft)		7.5 m (25 ft)		Volumen	Reichweite	
											m (ft)		
7.5 m (25 ft)	kg										*3660	3640	7.15
	lb										*8070	8020	(23.5)
6.0 m (20 ft)	kg						*3970	*3970			*3730	2750	8.20
	lb						*8750	*8750			*8220	6060	(26.9)
4.5 m (15 ft)	kg						*4450	*4450	*4190	3120	*3860	2320	8.82
	lb						*9810	*9810	*9240	6880	*8510	5110	(28.9)
3.0 m (10 ft)	kg				*6850	*6850	*5240	4410	*4520	3010	3760	2120	9.11
	lb				*15100	*15100	*11550	9720	*9960	6640	8290	4670	(29.9)
1.5 m (5 ft)	kg				*8510	6400	*6080	4130	*4930	2880	3710	2070	9.10
	lb				*18760	14110	*13400	9110	*10870	6350	8180	4560	(29.9)
Boden- niveau	kg		*8830	*8830	*9440	6100	*6700	3940	4960	2770	3890	2170	8.18
	lb		*19470	*19470	*20810	13450	*14770	8690	10930	6110	8580	4780	(26.8)
-1.5 m (-5 ft)	kg	*9800	*9800	*13550	12120	*9610	6020	*6920	3860		4400	2480	7.12
	lb	*21610	*21610	*29870	26720	*21190	13270	*15260	8510		9700	5470	(23.4)
-3.0 m (-10 ft)	kg	*14180	*14180	*13180	12340	*9040	6100	*6540	3900		*4660	3190	
	lb	*31260	*31260	*29060	27210	*19930	13450	*14420	8600		*10270	7030	
-4.5 m (-15 ft)	kg			*10580	*10580	*7350	6350						
	lb			*23320	*23320	*16200	14000						













1. Die Hublast richtet sich nach der Definition in SAE J1097 und ISO 10567.
2. Die Hublast der Serie HX darf auf festem, ebenem Untergrund maximal 75 % der Kipplast der Maschine bzw. 87 % der gesamten hydraulischen Hubkraft betragen.

3. Der Lasthaken befindet sich an der Rückseite des Tieflöffels.
4. (*) gibt die Lastbegrenzung durch die hydraulische Hubkraft an.













 Lastradius Frontauslage  Lastradius Seitenauslage bzw. 360 Grad

HX220 L

5,68 m (18' 8") Ausleger; 2,92 m (9' 7") Löffelstiel; 0,92 m³ Löffel (nach SAE gehäuft); 600 mm (24") 3-Steg-Bodenplatten.



Lasthöhe m (ft)		Lastradius										Max. Reichweite			
		1.5 m (5 ft)		3.0 m (10 ft)		4.5 m (15 ft)		6.0 m (20 ft)		7.5 m (25 ft)		Volumen		Reichweite m (ft)	
															
7.5 m (25 ft)	kg												*3310	3140	7.78
	lb												*7300	6920	(25.5)
6.0 m (20 ft)	kg									*2300	*2300		*3400	2450	8.74
	lb									*5070	*5070		*7500	5400	(28.7)
4.5 m (15 ft)	kg									*3970	*3970		*3530	2090	9.32
	lb									*8750	*8750		*7780	4610	(30.6)
3.0 m (10 ft)	kg			*9720	*9720	*6100	*6100	*4790	4460	*4180	3030		3440	1910	9.59
	lb			*21430	*21430	*13450	*13450	*10560	9830	*9220	6680		7580	4210	(31.5)
1.5 m (5 ft)	kg			*8850	*8850	*7900	6500	*5700	4150	*4660	2870		3380	1860	9.59
	lb			*19510	*19510	*17420	14330	*12570	9150	*10270	6330		7450	4100	(31.5)
Boden- niveau	kg			*9590	*9590	*9100	6100	*6440	3920	4930	2740		3520	1930	9.31
	lb			*21140	*21140	*20060	13450	*14200	8640	10870	6040		7760	4250	(30.5)
-1.5 m (-5 ft)	kg	*8840	*8840	*12650	11920	*9540	5940	*6810	3800	4860	2680		3910	2170	8.72
	lb	*19490	*19490	*27980	26280	*21030	13100	*15010	8380	10710	5910		8620	4780	(28.6)
-3.0 m (-10 ft)	kg	*12230	*12230	*13910	12080	*9260	5960	*6690	3800				*4420	2700	7.75
	lb	*26960	*26960	*30670	26630	*20410	13140	*14750	8380				*9740	5950	(25.4)
-4.5 m (-15 ft)	kg			*11800	*11800	*8060	6150						*4280	4080	6.16
	lb			*26010	*26010	*17770	13560						*9440	8990	(20.2)

5,68 m (18' 8") Ausleger; 3,90 m (12' 9") Löffelstiel; 0,92 m³ Löffel (nach SAE gehäuft); 600 mm (24") 3-Steg-Bodenplatten.

Lasthöhe m (ft)		Lastradius										Max. Reichweite				
		1.5 m (5 ft)		3.0 m (10 ft)		4.5 m (15 ft)		6.0 m (20 ft)		7.5 m (25 ft)		9.0 m (30 ft)		Volumen		Reichweite m (ft)
																
9.0 m (30 ft)	kg													*2700	*2700	7.66
	lb													*5950	*5950	(25.1)
7.5 m (25 ft)	kg									*1940	*1940			*2760	*2760	8.94
	lb									*4280	*4280			*6080	*6080	(29.3)
6.0 m (20 ft)	kg									*2790	*2790			*2850	2600	9.77
	lb									*6150	*6150			*6280	5730	(32.1)
4.5 m (15 ft)	kg									*3050	*3050	*2000	*2000	*2970	2300	10.28
	lb									*6720	*6720	*4410	*4410	*6550	5070	(33.7)
3.0 m (10 ft)	kg							*3900	*3900	*3510	*3510	*2870	2860	*3110	2140	10.52
	lb							*8600	*8600	*7740	*7740	*6330	6310	*6860	4720	(34.5)
1.5 m (5 ft)	kg			*11080	*11080	*6600	*6600	*4900	*4900	*4080	3820	*3410	2760	3080	2090	10.52
	lb			*24430	*24430	*14550	*14550	*10800	*10800	*8990	8420	*7520	6080	6790	4610	(34.5)
Boden- niveau	kg	*5300	*5300	*10640	*10640	*8200	*8200	*5820	5210	*4610	3630	*3490	2660	3180	2150	10.27
	lb	*11680	*11680	*23460	*23460	*18080	*18080	*12830	11490	*10160	8000	*7690	5860	7010	4740	(33.7)
-1.5 m (-5 ft)	kg	*7540	*7540	*11690	*11690	*9110	7900	*6440	4990	*4990	3510	*2330	*2330	3450	2340	9.75
	lb	*16620	*16620	*25770	*25770	*20080	17420	*14200	11000	*11000	7740	*5140	*5140	7610	5160	(32.0)
-3.0 m (-10 ft)	kg	*10030	*10030	*14390	*14390	*9320	7800	*6660	4910	*5070	3470			*3850	2750	8.91
	lb	*22110	*22110	*31720	*31720	*20550	17200	*14680	10820	*11180	7650			*8490	6060	(29.2)
-4.5 m (-15 ft)	kg	*13000	*13000	*13310	*13310	*8780	7890	*6290	4960					*3990	3640	7.62
	lb	*28660	*28660	*29340	*29340	*19360	17390	*13870	10930					*8800	8020	(25.0)
-6.0 m (-20 ft)	kg			*10560	*10560	*7050	*7050									
	lb			*23280	*23280	*15540	*15540									











- Die Hublast richtet sich nach der Definition in SAE J1097 und ISO 10567.
- Die Hublast der Serie HX darf auf festem, ebenem Untergrund maximal 75 % der Kippplast der Maschine bzw. 87 % der gesamten hydraulischen Hubkraft betragen.

- Der Lasthaken befindet sich an der Rückseite des Tieflöffels.
- (*) gibt die Lastbegrenzung durch die hydraulische Hubkraft an.











 Lastradius Frontauslage  Lastradius Seitenauslage bzw. 360 Grad

HX220 L ZWEITEILIGER AUSLEGER

5,65 m (18' 6") Zweiteiliger Ausleger; 2,00 m (6' 7") Löffelstiel; 0,92 m³ Löffel (nach SAE gehäuft); 600 mm (24") 3-Steg-Bodenplatten.



Lasthöhe m (ft)		Lastradius								Max. Reichweite		
		3.0 m (10 ft)		4.5 m (15 ft)		6.0 m (20 ft)		7.5 m (25 ft)		Volumen		Reichweite m (ft)
												
10.5 m (35 ft)	kg									*6180	*6180	4.64
	lb									*13620	*13620	(15.2)
9.0 m (30 ft)	kg									*6520	*6520	4.61
	lb									*14370	*14370	(15.1)
7.5 m (25 ft)	kg			*6710	*6710					*5270	4060	6.67
	lb			*14790	*14790					*11620	8950	(21.9)
6.0 m (20 ft)	kg			6780	*6870	*5850	4780			*4850	2970	7.80
	lb			15150	*15150	*12900	10540			*10690	6550	(25.6)
4.5 m (15 ft)	kg	*11340	*11340	*7750	7500	*6130	4610			4360	2470	8.45
	lb	*25000	*25000	*17090	16530	*13510	10160			9610	5450	(27.7)
3.0 m (10 ft)	kg			*8930	6810	*6590	4330	5200	2950	4030	2250	8.75
	lb			*19690	15010	*14530	9550	11460	6500	8880	4960	(28.7)
1.5 m (5 ft)	kg			*9600	6250	*6900	4060	5070	2830	3980	2200	8.75
	lb			*21160	13780	*15210	8950	11180	6240	8770	4850	(28.7)
Boden-niveau	kg			*9290	6020	*6800	3890	4990	2760	*3940	2330	8.44
	lb			*20480	13270	*14990	8580	11000	6080	*8690	5140	(27.7)
-1.5 m (-5 ft)	kg	*9840	*9840	*8130	6010	*6060	3850			*3360	2710	7.77
	lb	*21690	*21690	*17920	13250	*13360	8490			*7410	5970	(25.5)
-3.0 m (-10 ft)	kg			*6030	*6030	*4250	3970					
	lb			*13290	*13290	*9370	8750					

5,65 m (18' 6") Zweiteiliger Ausleger; 2,40 m (7' 10") Löffelstiel; 0,92 m³ Löffel (nach SAE gehäuft); 600 mm (24") 3-Steg-Bodenplatten.

Lasthöhe m (ft)		Lastradius								Max. Reichweite		
		3.0 m (10 ft)		4.5 m (15 ft)		6.0 m (20 ft)		7.5 m (25 ft)		Volumen		Reichweite m (ft)
												
9.0 m (30 ft)	kg									*5690	*5690	5.40
	lb									*12540	*12540	(17.7)
7.5 m (25 ft)	kg			*5860	*5860					*4850	3560	7.19
	lb			*12920	*12920					*10690	7850	(23.6)
6.0 m (20 ft)	kg			*6410	*6410	*5520	4860			*4510	2690	8.23
	lb			*14130	*14130	*12170	10710			*9940	5930	(27.0)
4.5 m (15 ft)	kg	*10290	*10290	*7300	*7300	*5860	4670	*4360	3080	4020	2260	8.85
	lb	*22690	*22690	*16090	*16090	*12920	10300	*9610	6790	8860	4980	(29.0)
3.0 m (10 ft)	kg			*8550	6940	*6370	4370	*5170	2960	3740	2060	9.14
	lb			*18850	15300	*14040	9630	*11140	6530	8250	4540	(30.0)
1.5 m (5 ft)	kg			*9440	6320	*6780	4070	5070	2820	3690	2020	9.13
	lb			*20810	13930	*14950	8970	11180	6220	8140	4450	(30.0)
Boden-niveau	kg	*8600	*8600	*9420	6000	*6820	3870	4960	2720	*3760	2120	8.84
	lb	*18960	*18960	*20770	13230	*15040	8530	10930	6000	*8290	4670	(29.0)
-1.5 m (-5 ft)	kg	*11240	*11240	*8510	5930	*6280	3800	*4460	2710	*3310	2440	8.21
	lb	*24780	*24780	*18760	13070	*13850	8380	*9830	5970	*7300	5380	(26.9)
-3.0 m (-10 ft)	kg			*6700	6040	*4870	3860					
	lb			*14770	13320	*10740	8510					











- Die Hublast richtet sich nach der Definition in SAE J1097 und ISO 10567.
- Die Hublast der Serie HX darf auf festem, ebenem Untergrund maximal 75 % der Kippplast der Maschine bzw. 87 % der gesamten hydraulischen Hubkraft betragen.

- Der Lasthaken befindet sich an der Rückseite des Tieflöffels.
- (*) gibt die Lastbegrenzung durch die hydraulische Hubkraft an.

 Lastradius Frontauslage  Lastradius Seitenauslage bzw. 360 Grad

HX220 L ZWEITEILIGER AUSLEGER

5,65 m (18' 6") Zweiteiliger Ausleger; 2,92 m (9' 7") Löffelstiel; 0,92 m³ Löffel (nach SAE gehäuft); 600 mm (24") 3-Steg-Bodenplatten.

Lasthöhe m (ft)		Lastradius								Max. Reichweite		
		3.0 m (10 ft)		4.5 m (15 ft)		6.0 m (20 ft)		7.5 m (25 ft)		Volumen		Reichweite m (ft)
												
9.0 m (30 ft)	kg lb			*3290 *7250	*3290 *7250					*4590 *10120	*4590 *10120	6.28 (20.6)
7.5 m (25 ft)	kg lb					*3520 *7760	*3520 *7760			*4020 *8860	3060 6750	7.83 (25.7)
6.0 m (20 ft)	kg lb			*5160 *11380	*5160 *11380	*4870 *10740	*4870 *10740	*2440 *5380	*2440 *5380	*3790 *8360	2370 5220	8.79 (28.8)
4.5 m (15 ft)	kg lb			*6680 *14730	*6680 *14730	*5480 *12080	4750 10470	*4380 *9660	3140 6920	3650 8050	2020 4450	9.36 (30.7)
3.0 m (10 ft)	kg lb	*12620 *27820	*12620 *27820	*8000 *17640	7130 15720	*6060 *13360	4430 9770	*4970 *10960	2990 6590	3400 7500	1850 4080	9.63 (31.6)
1.5 m (5 ft)	kg lb	*8680 *19140	*8680 *19140	*9130 *20130	6430 14180	*6580 *14510	4100 9040	5070 11180	2820 6220	3350 7390	1800 3970	9.63 (31.6)
Boden- niveau	kg lb	*9390 *20700	*9390 *20700	*9450 *20830	6000 13230	*6780 *14950	3850 8490	4930 10870	2690 5930	3500 7720	1880 4140	9.35 (30.7)
-1.5 m (-5 ft)	kg lb	*12500 *27560	11770 25950	*8880 *19580	5850 12900	*6460 *14240	3730 8220	*4770 *10520	2630 5800	*3200 *7050	2130 4700	8.77 (28.8)
-3.0 m (-10 ft)	kg lb	*9950 *21940	*9950 *21940	*7420 *16360	5890 12990	*5420 *11950	3750 8270					

1. Die Hublast richtet sich nach der Definition in SAE J1097 und ISO 10567.
2. Die Hublast der Serie HX darf auf festem, ebenem Untergrund maximal 75 % der Kipplast der Maschine bzw. 87 % der gesamten hydraulischen Hubkraft betragen.

3. Der Lasthaken befindet sich an der Rückseite des Tieflöffels.
4. (*) gibt die Lastbegrenzung durch die hydraulische Hubkraft an.

 Lastradius Frontauslage  Lastradius Seitenauslage bzw. 360 Grad



HX220 L LONG REACH

8,2 m (26' 11") Ausleger; 6,3 m (20' 8") Löffelstiel; 0,52 m³ Löffel (nach SAE gehäuft); 800 mm (32") 3-Steg-Bodenplatten.

Lasthöhe m (ft)	Lastradius										Max. Reichweite							
	4.5 m (15 ft)	6.0 m (20 ft)	7.5 m (25 ft)	9.0 m (30 ft)	10.5 m (35 ft)	12.0 m (40 ft)	13.5 m (45 ft)	Volumen	Reichweite	m (ft)								
10.5 m (35 ft)	kg											*1470	*1470	12.11				
	lb											*3240	*3240	(39.7)				
9.0 m (30 ft)	kg							*930	*930			*1490	*1490	13.11				
	lb							*2050	*2050			*3280	*3280	(43.0)				
7.5 m (25 ft)	kg							*1540	*1540			*1530	1350	13.84				
	lb							*3400	*3400			*3370	2980	(45.4)				
6.0 m (20 ft)	kg							*1590	*1590	*1600	*1600			*1580	1190	14.37		
	lb							*3510	*3510	*3530	*3530			*3480	2620	(47.1)		
4.5 m (15 ft)	kg							*1770	*1770	*1710	*1710	*1260	*1260	*1630	1080	14.72		
	lb							*3900	*3900	*3770	*3770	*2780	*2780	*3590	2380	(48.3)		
3.0 m (10 ft)	kg			*2500	*2500	*2200	*2200	*2000	*2000	*1860	1670	*1590	1260	*1700	1010	14.89		
	lb			*5510	*5510	*4850	*4850	*4410	*4410	*4100	3680	*3510	2780	*3750	2230	(48.9)		
1.5 m (5 ft)	kg	*5570	*5570	*3900	*3900	*3060	*3060	*2560	*2560	*2240	2050	*2030	1570	*1790	1200	14.90		
	lb	*12280	*12280	*8600	*8600	*6750	*6750	*5640	*5640	*4940	4520	*4480	3460	*3950	2650	(48.9)		
Boden- niveau	kg	*6930	6870	*4720	4590	*3580	3320	*2910	2490	*2490	1910	*2200	1480	*1820	1140	*1860	960	14.75
	lb	*15280	15150	*10410	10120	*7890	7320	*6420	5490	*5490	4210	*4850	3260	*4010	2510	*4100	2120	(48.4)
-1.5 m (-5 ft)	kg	*7750	6340	*5330	4220	*4020	3060	*3220	2320	*2700	1790	*2350	1400	*1570	1100	*1960	990	14.42
	lb	*17090	13980	*11750	9300	*8860	6750	*7100	5110	*5950	3950	*5180	3090	*3460	2430	*4320	2180	(47.3)
-3.0 m (-10 ft)	kg	*8150	6120	*5720	4000	*4330	2890	*3450	2190	*2870	1700	*2460	1340			*2060	1050	13.92
	lb	*17970	13490	*12610	8820	*9550	6370	*7610	4830	*6330	3750	*5420	2950			*4540	2310	(45.7)
-4.5 m (-15 ft)	kg	*8220	6060	*5890	3910	*4490	2810	*3590	2120	*2960	1660	*2490	1330			*2180	1170	13.20
	lb	*18120	13360	*12990	8620	*9900	6190	*7910	4670	*6530	3660	*5490	2930			*4810	2580	(43.3)
-6.0 m (-20 ft)	kg	*8020	6130	*5840	3920	*4500	2790	*3600	2110	*2940	1660					*2310	1370	12.25
	lb	*17680	13510	*12870	8640	*9920	6150	*7940	4650	*6480	3660					*5090	3020	(40.2)
-7.5 m (-25 ft)	kg	*7500	6310	*5550	4010	*4300	2850	*3420	2170	*2700	1730					*2430	1710	10.97
	lb	*16530	13910	*12240	8840	*9480	6280	*7540	4780	*5950	3810					*5360	3770	(36.0)
-9.0 m (-30 ft)	kg	*6570	*6570	*4920	4200	*3790	3000	*2890	2320									
	lb	*14480	*14480	*10850	9260	*8360	6610	*6370	5110									
-10.5 m (-35 ft)	kg	*4970	*4970	*3680	*3680													
	lb	*10960	*10960	*8110	*8110													











1. Die Hublast richtet sich nach der Definition in SAE J1097 und ISO 10567.
2. Die Hublast der Serie HX darf auf festem, ebenem Untergrund maximal 75 % der Kipplast der Maschine bzw. 87 % der gesamten hydraulischen Hubkraft betragen.

3. Der Lasthaken befindet sich an der Rückseite des Tieflöffels.
4. (*) gibt die Lastbegrenzung durch die hydraulische Hubkraft an.











 Lastradius Frontauslage  Lastradius Seitenauslage bzw. 360 Grad

HX220 L HIGH WALKER

5,68 m (18' 8") Ausleger; 2,00 m (6' 7") Löffelstiel; 0,92 m³ Löffel (nach SAE gehäuft); 600 mm (24") 3-Steg-Bodenplatten.

Lasthöhe m (ft)	Lastradius								Max. Reichweite			
	3.0 m (10 ft)		4.5 m (15 ft)		6.0 m (20 ft)		7.5 m (25 ft)		Volumen		Reichweite m (ft)	
												
7.5 m (25 ft)	kg									*3970	*3970	6.65
	lb									*8750	*8750	(21.8)
6.0 m (20 ft)	kg				*4400	*4400				*4020	3920	7.78
	lb				*9700	*9700				*8860	8640	(25.5)
4.5 m (15 ft)	kg		*5690	*5690	*4820	*4820				*4140	3330	8.43
	lb		*12540	*12540	*10630	*10630				*9130	7340	(27.7)
3.0 m (10 ft)	kg		*7420	*7420	*5570	*5570	*4780	3930		*4300	3060	8.74
	lb		*16360	*16360	*12280	*12280	*10540	8660		*9480	6750	(28.7)
1.5 m (5 ft)	kg		*8940	8430	*6340	5420	*5140	3810		4300	3010	8.73
	lb		*19710	18580	*13980	11950	*11330	8400		9480	6640	(28.6)
Boden-niveau	kg		*9640	8190	*6860	5250	*5370	3730		4540	3170	8.42
	lb		*21250	18060	*15120	11570	*11840	8220		10010	6990	(27.6)
-1.5 m (-5 ft)	kg	*13940	*13940	*9580	8160	*6950	5190			*4840	3630	7.76
	lb	*30730	*30730	*21120	17990	*15320	11440			*10670	8000	(25.5)
-3.0 m (-10 ft)	kg	*12450	*12450	*8770	8290	*6310	5290			*4800	4780	6.61
	lb	*27450	*27450	*19330	18280	*13910	11660			*10580	10540	(21.7)
-4.5 m (-15 ft)	kg	*9410	*9410									
	lb	*20750	*20750									

5,68 m (18' 8") Ausleger; 2,40 m (7' 10") Löffelstiel; 0,92 m³ Löffel (nach SAE gehäuft); 600 mm (24") 3-Steg-Bodenplatten.

Lasthöhe m (ft)	Lastradius								Max. Reichweite				
	1.5 m (5 ft)		3.0 m (10 ft)		4.5 m (15 ft)		6.0 m (20 ft)		7.5 m (25 ft)		Volumen		Reichweite m (ft)
													
7.5 m (25 ft)	kg										*3660	*3660	7.15
	lb										*8070	*8070	(23.5)
6.0 m (20 ft)	kg						*3970	*3970			*3730	3580	8.20
	lb						*8750	*8750			*8220	7890	(26.9)
4.5 m (15 ft)	kg						*4450	*4450	*4190	4060	*3860	3070	8.82
	lb						*9810	*9810	*9240	8950	*8510	6770	(28.9)
3.0 m (10 ft)	kg				*6850	*6850	*5240	*5240	*4520	3940	*4020	2840	9.11
	lb				*15100	*15100	*11550	*11550	*9960	8690	*8860	6260	(29.9)
1.5 m (5 ft)	kg				*8510	8500	*6080	5430	*4930	3810	4010	2780	9.10
	lb				*18760	18740	*13400	11970	*10870	8400	8840	6130	(29.9)
Boden-niveau	kg		*8830	*8830	*9440	8180	*6700	5230	*5250	3700	4200	2920	8.81
	lb		*19470	*19470	*20810	18030	*14770	11530	*11570	8160	9260	6440	(28.9)
-1.5 m (-5 ft)	kg	*9800	*9800	*13550	*13550	*9610	8090	*6920	5140		*4590	3300	8.18
	lb	*21610	*21610	*29870	*29870	*21190	17840	*15260	11330		*10120	7280	(26.8)
-3.0 m (-10 ft)	kg	*14180	*14180	*13180	*13180	*9040	8170	*6540	5190		*4660	4190	7.12
	lb	*31260	*31260	*29060	*29060	*19930	18010	*14420	11440		*10270	9240	(23.4)
-4.5 m (-15 ft)	kg			*10580	*10580	*7350	*7350						
	lb			*23320	*23320	*16200	*16200						













1. Die Hublast richtet sich nach der Definition in SAE J1097 und ISO 10567.
2. Die Hublast der Serie HX darf auf festem, ebenem Untergrund maximal 75 % der Kipplast der Maschine bzw. 87 % der gesamten hydraulischen Hubkraft betragen.

3. Der Lasthaken befindet sich an der Rückseite des Tieflöffels.
4. (*) gibt die Lastbegrenzung durch die hydraulische Hubkraft an.













 Lastradius Frontauslage  Lastradius Seitenauslage bzw. 360 Grad

HX220 L HIGH WALKER

5,68 m (18' 8") Ausleger; 2,92 m (9' 7") Löffelstiel; 0,92 m³ Löffel (nach SAE gehäuft); 600 mm (24") 3-Steg-Bodenplatten.



Lasthöhe m (ft)	Lastradius										Max. Reichweite			
	1.5 m (5 ft)		3.0 m (10 ft)		4.5 m (15 ft)		6.0 m (20 ft)		7.5 m (25 ft)		Volumen		Reichweite m (ft)	
														
7.5 m (25 ft)	kg											*3310	*3310	7.78
	lb											*7300	*7300	(25.5)
6.0 m (20 ft)	kg								*2300	*2300		*3400	*3210	8.74
	lb								*5070	*5070		*7500	*7080	(28.7)
4.5 m (15 ft)	kg							*3970	*3970	*3780	*3780	*3530	2780	9.32
	lb							*8750	*8750	*8330	*8330	*7780	6130	(30.6)
3.0 m (10 ft)	kg		*9720	*9720	*6100	*6100	*4790	*4790	*4180	3970		*3680	2580	9.59
	lb		*21430	*21430	*13450	*13450	*10560	*10560	*9220	8750		*8110	5690	(31.5)
1.5 m (5 ft)	kg		*8850	*8850	*7900	*7900	*5700	5450	*4660	3800		3660	2530	9.59
	lb		*19510	*19510	*17420	*17420	*12570	12020	*10270	8380		8070	5580	(31.5)
Boden-niveau	kg		*9590	*9590	*9100	8180	*6440	5210	*5060	3670		3810	2630	9.31
	lb		*21140	*21140	*20060	18030	*14200	11490	*11160	8090		8400	5800	(30.5)
-1.5 m (-5 ft)	kg	*8840	*8840	*12650	*12650	*9540	8010	*6810	5080	5240	3610	4230	2930	8.72
	lb	*19490	*19490	*27890	*27890	*21030	17660	*15010	11200	11550	7960	9330	6460	(28.6)
-3.0 m (-10 ft)	kg	*12230	*12230	*13910	*13910	*9260	8040	*6690	5080			*4420	3590	7.75
	lb	*26960	*26960	*30670	*30670	*20410	17730	*14750	11200			*9740	7910	(25.4)
-4.5 m (-15 ft)	kg		*11800	*11800	*8060	*8060						*4280	*4280	6.16
	lb		*26010	*26010	*17770	*17770						*9440	*9440	(20.2)

5,68 m (18' 8") Ausleger; 3,90 m (12' 9") Löffelstiel; 0,92 m³ Löffel (nach SAE gehäuft); 600 mm (24") 3-Steg-Bodenplatten.

Lasthöhe m (ft)	Lastradius										Max. Reichweite					
	1.5 m (5 ft)		3.0 m (10 ft)		4.5 m (15 ft)		6.0 m (20 ft)		7.5 m (25 ft)		9.0 m (30 ft)		Volumen		Reichweite m (ft)	
																
9.0 m (30 ft)	kg												*2700	*2700	7.66	
	lb												*5950	*5950	(25.1)	
7.5 m (25 ft)	kg								*1940	*1940			*2760	*2760	8.94	
	lb								*4280	*4280			*6080	*6080	29.3	
6.0 m (20 ft)	kg								*2790	*2790			*2850	2600	9.77	
	lb								*6150	*6150			*6280	5730	(32.1)	
4.5 m (15 ft)	kg								*3050	*3050	*2000	*2000	*2970	2300	10.28	
	lb								*6720	*6720	*4410	*4410	*6550	5070	(33.7)	
3.0 m (10 ft)	kg						*3900	*3900	*3510	*3510	*2870	2860	*3110	2140	10.52	
	lb						*8600	*8600	*7740	*7740	*6330	6310	*6860	4720	(34.5)	
1.5 m (5 ft)	kg		*11080	*11080	*6600	*6600	*4900	*4900	*4080	3820	*3410	2760	3080	2090	10.52	
	lb		*24430	*24430	*14550	*14550	*10800	*10800	*8990	8420	*7520	6080	6790	4610	(34.5)	
Boden-niveau	kg	*5300	*5300	*10640	*10640	*8200	*8200	*5820	5210	*4610	3630	*3490	2660	3180	10.27	
	lb	*11680	*11680	*23460	*23460	*18080	*18080	*12830	11490	*10160	8000	*7690	5860	7010	4740	(33.7)
-1.5 m (-5 ft)	kg	*7540	*7540	*11690	*11690	*9110	7900	*6440	4990	*4990	3510	*2330	*2330	3450	2340	9.75
	lb	*16620	*16620	*25770	*25770	*20080	17420	*14200	11000	*11000	7740	*5140	*5140	7610	5160	(32.0)
-3.0 m (-10 ft)	kg	*10030	*10030	*14390	*14390	*9320	7800	*6660	4910	*5070	3470			*3850	2750	8.91
	lb	*22110	*22110	*31720	*31720	*20550	17200	*14680	10820	*11180	7650			*8490	6060	29.2
-4.5 m (-15 ft)	kg	*13000	*13000	*13310	*13310	*8780	7890	*6290	4960					*3990	3640	7.62
	lb	*28660	*28660	*29340	*29340	*19360	17390	*13870	10930					*8800	8020	(25.0)
-6.0 m (-20 ft)	kg		*10560	*10560	*7050	*7050										
	lb		*23280	*23280	*15540	*15540										











- Die Hublast richtet sich nach der Definition in SAE J1097 und ISO 10567.
- Die Hublast der Serie HX darf auf festem, ebenem Untergrund maximal 75 % der Kipplast der Maschine bzw. 87 % der gesamten hydraulischen Hubkraft betragen.

- Der Lasthaken befindet sich an der Rückseite des Tieflöffels.
- (*) gibt die Lastbegrenzung durch die hydraulische Hubkraft an.













 Lastradius Frontauslage  Lastradius Seitenauslage bzw. 360 Grad

HX220 NL

5,65 m (18' 6") Ausleger; 2,00 m (6' 7") Löffelstiel; 0,87 m³ Löffel (nach SAE gehäuft); 500 mm (20") 3-Steg-Bodenplatten.

Lasthöhe m (ft)		Lastradius								Max. Reichweite		
		3.0 m (10 ft)		4.5 m (15 ft)		6.0 m (20 ft)		7.5 m (25 ft)		Volumen		Reichweite m (ft)
												
7.5 m (25 ft)	kg lb									*4000 *8820	3810 8400	6.61 (21.7)
6.0 m (20 ft)	kg lb					*4420 *9740	4380 9660			*4060 *8950	2800 6170	7.75 (25.4)
4.5 m (15 ft)	kg lb			*5670 *12500	*5670 *12500	*4840 *10670	4230 9330			*4200 *9260	2340 5160	8.41 (27.6)
3.0 m (10 ft)	kg lb			*7430 *16380	6170 13600	*5600 *12350	3990 8800	*4830 *10650	2750 6060	*4360 *9610	2130 4700	8.71 (28.6)
1.5 m (5 ft)	kg lb			*8990 *19820	5700 12570	*6390 *14090	3760 8290	*5190 *11440	2640 5820	4330 9550	2080 4590	8.71 (28.6)
Boden- niveau	kg lb			*9720 *21430	5490 12100	*6930 *15280	3610 7960	5380 11860	2570 5670	4570 10080	2190 4830	8.40 (27.6)
-1.5 m (-5 ft)	kg lb	*14170 *31240	10580 23320	*9690 *21360	5460 12040	*7030 *15500	3560 7850			*4930 *10870	2540 5600	7.73 (25.4)
-3.0 m (-10 ft)	kg lb	*12680 *27950	10790 23790	*8900 *19620	5570 12280	*6390 *14090	3650 8050			*4910 *10820	3380 7450	6.58 (21.6)

5,65 m (18' 6") Ausleger; 2,00 m (6' 7") Löffelstiel; 0,87 m³ Löffel (nach SAE gehäuft); 500 mm (20") 3-Steg-Bodenplatten.

Lasthöhe m (ft)		Lastradius								Max. Reichweite				
		1.5 m (5 ft)		3.0 m (10 ft)		4.5 m (15 ft)		6.0 m (20 ft)		7.5 m (25 ft)		Volumen		Reichweite m (ft)
														
7.5 m (25 ft)	kg lb											*3690 *8140	3360 7410	7.12 (23.4)
6.0 m (20 ft)	kg lb							*3990 *8800	*3990 *8800			*3780 *8330	2540 5600	8.18 (26.8)
4.5 m (15 ft)	kg lb							*4460 *9830	4280 9440	*4050 *8930	2860 6310	*3910 *8620	2140 4720	8.80 (28.9)
3.0 m (10 ft)	kg lb					*6850 *15100	6280 13850	*5260 *11600	4020 8860	*4560 *10050	2760 6080	*4080 *8990	1950 4300	9.09 (29.8)
1.5 m (5 ft)	kg lb					*8540 *18830	5750 12680	*6120 *13490	3760 8290	*4980 *10980	2630 5800	4030 8880	1910 4210	9.08 (29.8)
Boden- niveau	kg lb			*9080 *20020	*9080 *20020	*9520 *20990	5470 12060	*6760 *14900	3580 7890	*5310 *11710	2540 5600	4220 9300	2000 4410	8.79 (28.8)
-1.5 m (-5 ft)	kg lb	*9930 *21890	*9930 *21890	*13780 *30380	10400 22930	*9710 *21410	5400 11900	*6990 *15410	3510 7740			*4670 *10300	2280 5030	8.16 (26.8)
-3.0 m (-10 ft)	kg lb	*14320 *31570	*14320 *31570	*13400 *29540	10600 23370	*9170 *20220	5470 12060	*6630 *14620	3550 7830			*4750 *10470	2940 6480	7.09 (23.3)
-4.5 m (-15 ft)	kg lb			*10790 *23790	*10790 *23790	*7470 *16470	5710 12590							













1. Die Hublast richtet sich nach der Definition in SAE J1097 und ISO 10567.
2. Die Hublast der Serie HX darf auf festem, ebenem Untergrund maximal 75 % der Kipplast der Maschine bzw. 87 % der gesamten hydraulischen Hubkraft betragen.

3. Der Lasthaken befindet sich an der Rückseite des Tieflöffels.
4. (*) gibt die Lastbegrenzung durch die hydraulische Hubkraft an.

 Lastradius Frontauslage  Lastradius Seitenauslage bzw. 360 Grad











HX220 NL

5,65 m (18' 6") Ausleger; 2,92 m (9' 7") Löffelstiel; 0,87 m³ Löffel (nach SAE gehäuft); 500 mm (20") 3-Steg-Bodenplatten.

Lasthöhe m (ft)		Lastradius								Max. Reichweite				
		1.5 m (5 ft)		3.0 m (10 ft)		4.5 m (15 ft)		6.0 m (20 ft)		7.5 m (25 ft)		Volumen	Reichweite	
														m (ft)
7.5 m (25 ft)	kg lb											*3350 *7390	2890 6370	7.76 (25.5)
6.0 m (20 ft)	kg lb									*2140 *4720	*2140 *4720	*3440 *7580	2250 4960	8.73 (28.6)
4.5 m (15 ft)	kg lb							*3970 *8750	*3970 *8750	*3810 *8400	2900 6390	*3580 *7890	1920 4230	9.30 (30.5)
3.0 m (10 ft)	kg lb			*9630 *21230	*9630 *21230	*6090 *13430	*6090 *13430	*4810 *10600	4060 8950	*4210 *9280	2770 6110	3730 8220	1750 3860	9.58 (31.4)
1.5 m (5 ft)	kg lb			*9210 *20300	*9210 *20300	*7920 *17460	5830 12850	*5730 *12630	3780 8330	*4700 *10360	2630 5800	3680 8110	1710 3770	9.57 (31.4)
Boden- niveau	kg lb			*9810 *21630	*9810 *21630	*9160 *20190	5460 12040	*6490 *14310	3560 7850	*5120 *11290	2510 5530	3830 8440	1780 3920	9.29 (30.5)
-1.5 m (-5 ft)	kg lb	*8950 *19730	*8950 *19730	*12850 *28330	10220 22530	*9630 *21230	5320 11730	*6880 *15170	3450 7610	5250 11570	2450 5400	4250 9370	2000 4410	8.71 (28.6)
-3.0 m (-10 ft)	kg lb	*12340 *27210	*12340 *27210	*14120 *31130	10360 22840	*9380 *20680	5340 11770	*6770 *14930	3450 7610			*4490 *9900	2490 5490	7.73 (25.4)
-4.5 m (-15 ft)	kg lb			*12010 *26480	10690 23570	*8180 *18030	5510 12150					*4360 *9610	3750 8270	6.14 (20.1)

HX220 NL ZWEITEILIGER AUSLEGER

5,65 m (18' 6") Zweiteiliger Ausleger; 2,00 m (6' 7") Löffelstiel; 0,87 m³ Löffel (nach SAE gehäuft); 500 mm (20") 3-Steg-Bodenplatten.

Lasthöhe m (ft)		Lastradius						Max. Reichweite					
		3.0 m (10 ft)		4.5 m (15 ft)		6.0 m (20 ft)		7.5 m (25 ft)		Volumen	Reichweite		
												m (ft)	
10.5 m (35 ft)	kg lb									*6200 *13670	*6200 *13670	4.64 (15.2)	
9.0 m (30 ft)	kg lb									*6560 *14460	*6560 *14460	4.60 (15.1)	
7.5 m (25 ft)	kg lb			*6750 *14880	*6750 *14880					*5330 *11750	3710 8180	6.66 (21.9)	
6.0 m (20 ft)	kg lb			*6910 *15230	*6910 *15230	*5910 *13030	4340 9570			*4920 *10850	2720 6000	7.79 (25.6)	
4.5 m (15 ft)	kg lb	*11400 *25130	*11400 *25130	*7810 *17220	6710 14790	*6200 *13670	4190 9240			4680 10320	2270 5000	8.45 (27.7)	
3.0 m (10 ft)	kg lb			*9020 *19890	6090 13430	*6670 *14700	3930 8660	*5380 *11860	2700 5950	4350 9590	2060 4540	8.75 (28.7)	
1.5 m (5 ft)	kg lb			*9720 *21430	5600 12350	*6990 *15410	3690 8140	*5410 *11930	2590 5710	4300 9480	2020 4450	8.75 (28.7)	
Boden- niveau	kg lb			*9430 *20790	5390 11880	*6900 *15210	3540 7800	*5130 *11310	2520 5560	*4020 *8860	2140 4720	8.43 (27.7)	
-1.5 m (-5 ft)	kg lb	*10050 *22160	*10050 *22160	*8270 *18230	5380 11860	*6170 *13600	3500 7720			*3440 *7580	2490 5490	7.77 (25.5)	
-3.0 m (-10 ft)	kg lb			*6160 *13580	5520 12170	*4350 *9590	3610 7960						

1. Die Hublast richtet sich nach der Definition in SAE J1097 und ISO 10567.

2. Die Hublast der Serie HX darf auf festem, ebenem Untergrund maximal 75 % der Kipplast der Maschine bzw. 87 % der gesamten hydraulischen Hubkraft betragen.











3. Der Lasthaken befindet sich an der Rückseite des Tieflöffels.

4. (*) gibt die Lastbegrenzung durch die hydraulische Hubkraft an.











 Lastradius Frontauslage  Lastradius Seitenauslage bzw. 360 Grad

HX220 NL ZWEITEILIGER AUSLEGER

5,65 m (18' 6") Zweiteiliger Ausleger; 2,40 m (7' 10") Löffelstiel; 0,87 m³ Löffel (nach SAE gehäuft); 500 mm (20") 3-Steg-Bodenplatten.

Lasthöhe m (ft)	Lastradius								Max. Reichweite			
	3.0 m (10 ft)		4.5 m (15 ft)		6.0 m (20 ft)		7.5 m (25 ft)		Volumen	Reichweite		
											m (ft)	
9.0 m (30 ft)	kg								*5730	5470	5.39	
	lb								*12630	12060	(17.7)	
7.5 m (25 ft)	kg		*5870	*5870					*4900	3260	7.18	
	lb		*12940	*12940					*10800	7190	(23.6)	
6.0 m (20 ft)	kg		*6440	*6440	*5570	4420			*4570	2460	8.23	
	lb		*14200	*14200	*12280	9740			*10080	5420	(27.0)	
4.5 m (15 ft)	kg	*10330	*10330	*7350	6840	*5920	4240	*4360	2820	4330	2070	8.84
	lb	*22770	*22770	*16200	15080	*13050	9350	*9610	6220	9550	4560	(29.0)
3.0 m (10 ft)	kg		*8630	6210	*6450	3960	*5240	2710	4040	1890	9.13	
	lb		*19030	13690	*14220	8730	*11550	5970	8910	4170	(30.0)	
1.5 m (5 ft)	kg		*9550	5650	*6870	3700	*5360	2580	3990	1850	9.13	
	lb		*21050	12460	*15150	8160	*11820	5690	8800	4080	(30.0)	
Boden- niveau	kg	*8600	*8600	*9560	5370	*6920	3510	*5230	2490	*3840	1950	8.83
	lb	*18960	*18960	*21080	11840	*15260	7740	*11530	5490	*8470	4300	(29.0)
-1.5 m (-5 ft)	kg	*11450	10280	*8660	5310	*6390	3450	*4540	2470	*3390	2230	2.21
	lb	*25240	22660	*19090	11710	*14090	7610	*10010	5450	*7470	4920	(26.9)
-3.0 m (-10 ft)	kg		*6840	5400	*4980	3510						
	lb		*15080	11900	*10980	7740						

5,65 m (18' 6") Zweiteiliger Ausleger; 2,92 m (9' 7") Löffelstiel; 0,87 m³ Löffel (nach SAE gehäuft); 500 mm (20") 3-Steg-Bodenplatten.

Lasthöhe m (ft)	Lastradius								Max. Reichweite			
	3.0 m (10 ft)		4.5 m (15 ft)		6.0 m (20 ft)		7.5 m (25 ft)		Volumen	Reichweite		
											m (ft)	
9.0 m (30 ft)	kg		*3290	*3290					*4600	4260	6.28	
	lb		*7250	*7250					*10140	9390	(20.6)	
7.5 m (25 ft)	kg				*3530	*3530			*4030	2800	7.83	
	lb				*7780	*7780			*8880	6170	(25.7)	
6.0 m (20 ft)	kg		*5170	*5170	*4870	4510	*2440	*2440	*3800	2170	8.78	
	lb		*11400	*11400	*10740	9940	*5380	*5380	*8380	4780	(28.8)	
4.5 m (15 ft)	kg		*6720	*6720	*5540	4310	*4390	2860	*3740	1850	9.36	
	lb		*14820	*14820	*12210	9500	*9680	6310	*8250	4080	(30.7)	
3.0 m (10 ft)	kg	*12710	12080	*8080	6370	*6130	4020	*5040	2720	3690	1690	9.63
	lb	*28020	26630	*17810	14040	*13510	8860	*11110	6000	8140	3730	(31.6)
1.5 m (5 ft)	kg	*8700	*8700	*9240	5740	*6660	3720	*5240	2570	3640	1650	9.63
	lb	*19180	*19180	*20370	12650	*14680	8200	*11550	5670	8020	3640	(31.6)
Boden- niveau	kg	*9390	*9390	*9580	5360	*6880	3490	*5260	2450	*3610	1720	9.35
	lb	*20700	*20700	*21120	11820	*15170	7690	*11600	5400	*7960	3790	(30.7)
-1.5 m (-5 ft)	kg	*12500	10070	*9020	5230	*6570	3380	*4860	2400	*3270	1950	8.77
	lb	*27560	22200	*19890	11530	*14480	7450	*10710	5290	*7210	4300	(28.8)
-3.0 m (-10 ft)	kg	*10150	*10150	*7560	5270	*5530	3400					
	lb	*22380	*22380	*16670	11620	*12190	7500					

1. Die Hublast richtet sich nach der Definition in SAE J1097 und ISO 10567.
2. Die Hublast der Serie HX darf auf festem, ebenem Untergrund maximal 75 % der Kipplast der Maschine bzw. 87 % der gesamten hydraulischen Hubkraft betragen.

3. Der Lasthaken befindet sich an der Rückseite des Tieflöffels.
4. (*) gibt die Lastbegrenzung durch die hydraulische Hubkraft an.

HX220 L

MOTOR	STD	OPT
Cummins-Motor QSB 6.7	●	
HYDRAULIKSYSTEM		
IPC (Intelligent Power Control)		
3 Leistungsstufen, 2 Arbeitsarten, Benutzermodus	●	
Variable Leistungssteuerung	●	
Pumpenfördermengenregelung	●	
Volumenstromregelung für Anbaugerät-Betriebsart		●
Automatischer Motorleerlauf	●	
Automatische Motorabschaltung		●
Elektronische Gebläsesteuerung	●	
KABINE UND INNENRAUM		
Kabine nach ISO-Norm		
Obenrunder Frontscheibenwischer	●	
Radio/USB-Player	●	
Mobiltelefon-Freisprecheinrichtung mit USB	●	
12-Volt-Steckdose (Wandler 24 VDC auf 12 VDC)	●	
Elektrisches Signalhorn	●	
Allwetter-Stahlkabine mit 360°-Rundumsicht	●	
Sicherheitsglasscheiben	●	
Frontscheibe einschiebbar	●	
Seitenscheibe (links) als Schiebefenster	●	
Abschließbare Tür	●	
Warmhalte- und Kühlbox	●	
Aufbewahrungsfach und Aschenbecher	●	
Kabinendachabdeckung transparent	●	
Sonnenblende	●	
Tür- und Kabinenschlösser, ein Schlüssel	●	
Mechanisch gefederter, beheizter Sitz	●	
Vorsteuerdruckunterstützter Joystick	●	
Konsole höhenverstellbar	●	
Automatische Klimaregelung		
Klimaanlage und Heizung	●	
Scheibenheizung	●	
Starthilfe (Ansaugluftvorwärmung) bei kalten Temperaturen	●	
Zentrale Überwachung		
8-Zoll-LCD	●	
Motordrehzahl oder Tageszähler/Beschleunigung	●	
Motor Kühlmittel-Temperaturanzeige	●	
Max. Leistung	●	
Kriechgang/Schnellgang	●	
Automatischer Leerlauf	●	
Überlast	●	
Motor überprüfen	●	
Luftfilter verstopft	●	
Anzeigen	●	
ÖKO-Anzeigen	●	
Kraftstoffstandanzeige	●	
Anzeige für die Hydrauliköltemperatur	●	
Kraftstoffvorwärmer	●	
Warnungen	●	
Kommunikationsfehler	●	
Batterie niedrig	●	
Uhr	●	
Kabinenscheinwerfer		●
Regenschutz für Kabinenfrontfenster		●
Kabinendachabdeckung in Stahl		●
Sitz		
Einstellbarer Fahrersitz mit Luftfederung und Heizung		●
Kabinen-FOPS/FOG (ISO/DIN 10262) Stufe 2		
FOPS (Schutzeinrichtung gegen herabfallende Gegenstände) - ISO 3449 Stufe 2		●
FOG (Schutzaufbau gegen herabfallende Gegenstände)		●
Kabinen-ROPS (ISO 12117-2)		
ROPS (Überrollschutz)	●	

SICHERHEIT	STD	OPT
Batterie Hauptschalter	●	
Heckkamera	●	
Kameragestützte virtuelle Draufsicht incl. Bewegobjektüberwachung (AAVM + MOD)		●
Vier Arbeitsscheinwerfer	●	
Fahralarm	●	
Arbeitsscheinwerfer hinten		●
Rundumleuchte		●
Automatische Schwenkbremse	●	
Auslegerhaltesystem	●	
Stielhaltesystem	●	
Sicherheitsventil für Auslegerzylinder mit Überlastwarneinrichtung	●	
Sicherheitsventil für Löffelstielzylinder		●
Schwenksperre		●
Drei Außenrückspiegel	●	
SONSTIGES		
Ausleger		
5,68 m; 18' 8" Ausleger	●	
5,65 m; 18' 6" Zweiteiliger Ausleger		●
8,2 m; 26' 11" Long reach		●
Löffelstiel		
2,0 m; 6' 7"		●
2,4 m; 7' 10"		●
2,92 m; 9' 7"	●	
3,9 m; 12' 10"		●
6,3 m; 20' 8" Long reach		●
Herausnehmbares Kühlerstaubgitter	●	
Herausnehmbarer Vorratsbehälter	●	
Kraftstoffvorfilter	●	
Kraftstoffvorwärmer	●	
Selbstdiagnosesystem	●	
Hi MATE (Maschinenmanagementsystem)	●	
Batterien (2 x 12 V x 100 Ah)	●	
Kraftstoffbetankungspumpe (50 l/min)	●	
Einfach wirkende Verrohrung (Hydraulikhammer usw.)		●
Doppelt wirkende Verrohrung (Zweischalengreifer usw.)	●	
Verrohrung für drehende Anbaugeräte		●
Verrohrung für hydraulische Schnellwechsler		●
Schnellwechsler		●
Auslegerschwimmsteuerung		●
Einpedal-Geradeausfahrt		●
Druckspeicher beim Senken der Arbeitseinrichtung	●	
Bedienschema-Umschaltventil (2 Muster)		●
Feinsteuerung Schwenken		●
Werkzeugsatz		●
UNTERWAGEN		
Unterbodenschutz Unterwagen (extra)		●
Unterbodenschutz Unterwagen (normal)	●	
Bodenplatten		
3-Steg-Bodenplatten (600 mm; 24")	●	
3-Steg-Bodenplatten (700 mm; 28")		●
3-Steg-Bodenplatten (800 mm; 32")		●
3-Steg-Bodenplatten (900 mm; 36")		●
2-Steg-Bodenplatten (600 mm; 24")		●
2-Steg-Bodenplatten (700 mm; 28")		●
Laufrollenschutz	●	
Laufrollenschutz "High Walker"		●

STD = Standard
OPT = Optional

HX220 NL

MOTOR	STD	OPT
Cummins-Motor QSB 6.7	●	
HYDRAULIKSYSTEM		
IPC (Intelligent Power Control)		
3 Leistungsstufen, 2 Arbeitsarten, Benutzermodus	●	
Variable Leistungssteuerung	●	
Pumpenfördermengenregelung	●	
Volumenstromregelung für Anbaugerät-Betriebsart		●
Automatischer Motorleerlauf	●	
Automatische Motorabschaltung		●
Elektronische Gebläsesteuerung	●	
KABINE UND INNENRAUM		
Kabine nach ISO-Norm		
Obenrunder Frontscheibenwischer	●	
Radio/USB-Player	●	
Mobiltelefon-Freisprecheinrichtung mit USB	●	
12-Volt-Steckdose (Wandler 24 VDC auf 12 VDC)	●	
Elektrisches Signalhorn	●	
Allwetter-Stahlkabine mit 360°-Rundumsicht	●	
Sicherheitsglasscheiben	●	
Frontscheibe einschiebbar	●	
Seitenscheibe (links) als Schiebefenster	●	
Abschließbare Tür	●	
Warmhalte- und Kühlbox	●	
Aufbewahrungsfach und Aschenbecher	●	
Kabinendachabdeckung transparent	●	
Sonnenblende	●	
Tür- und Kabinenschlösser, ein Schlüssel	●	
Mechanisch gefederter, beheizter Sitz	●	
Vorsteuerdruckunterstützter Joystick	●	
Konsole höhenverstellbar	●	
Automatische Klimaregelung		
Klimaanlage und Heizung	●	
Scheibenheizung	●	
Starthilfe (Ansaugluftvorwärmung) bei kalten Temperaturen	●	
Zentrale Überwachung		
8-Zoll-LCD	●	
Motordrehzahl oder Tageszähler/Beschleunigung	●	
Motorkühlmittel-Temperaturanzeige	●	
Max. Leistung	●	
Kriechgang/Schnellgang	●	
Automatischer Leerlauf	●	
Überlast	●	
Motor überprüfen	●	
Luftfilter verstopft	●	
Anzeigen	●	
ÖKO-Anzeigen	●	
Kraftstoffstandanzeige	●	
Anzeige für die Hydrauliköltemperatur	●	
Kraftstoffvorwärmer	●	
Warnungen	●	
Kommunikationsfehler	●	
Batterie niedrig	●	
Uhr	●	
Kabinenscheinwerfer		●
Regenschutz für Kabinenfrontfenster		●
Kabinendachabdeckung in Stahl		●
Sitz		
Einstellbarer Fahrersitz mit Luftfederung und Heizung		●
Kabinen-FOPS/FOG (ISO/DIN 10262) Stufe 2		
FOPS (Schutzeinrichtung gegen herabfallende Gegenstände) - ISO 3449 Stufe 2		●
FOG (Schutzaufbau gegen herabfallende Gegenstände)		●
Kabinen-ROPS (ISO 12117-2)		
ROPS (Überrollschutz)	●	

SICHERHEIT	STD	OPT
Batterie Hauptschalter	●	
Heckkamera	●	
Kameragestützte virtuelle Draufsicht incl. Bewegobjektüberwachung (AAVM + MOD)		●
Vier Arbeitsscheinwerfer	●	
Fahralarm	●	
Arbeitsscheinwerfer hinten		●
Rundumleuchte		●
Automatische Schwenkbremse	●	
Auslegerhaltesystem	●	
Stielhaltesystem	●	
Sicherheitsventil für Auslegerzylinder mit Überlastwarneinrichtung	●	
Sicherheitsventil für Löffelstielzylinder		●
Schwenksperre		●
Drei Außenrückspiegel	●	
SONSTIGES		
Ausleger		
5,65 m; 18' 6" Ausleger	●	
5,65 m; 18' 6" Zweiteiliger Ausleger		●
Löffelstiel		
2,0 m; 6' 7"		●
2,4 m; 7' 10"		●
2,92 m; 9' 7"	●	
Herausnehmbares Kühlerstaubgitter	●	
Herausnehmbarer Vorratsbehälter	●	
Kraftstoffvorfilter	●	
Kraftstoffvorwärmer einfach	●	
Kraftstoffvorwärmer zweifach		●
Selbstdiagnosesystem	●	
Hi MATE (Maschinenmanagementsystem)	●	
Batterien (2 x 12 V x 100 Ah)	●	
Kraftstoffbetankungspumpe (50 l/min)	●	
Einfach wirkende Verrohrung (Hydraulikhammer usw.)		●
Doppelt wirkende Verrohrung (Zweischalengreifer usw.)	●	
Verrohrung für drehende Anbaugeräte		●
Verrohrung für hydraulische Schnellwechsler		●
Schnellwechsler		●
Einpedal-Geradeausfahrt		●
Druckspeicher beim Senken der Arbeitseinrichtung	●	
Bedienschema-Umschaltventil (2 Muster)		●
Feinsteuerung Schwenken		●
Werkzeugsatz		●
UNTERWAGEN		
Unterbodenschutz Unterwagen (extra)		●
Unterbodenschutz Unterwagen (normal)	●	
Bodenplatten		
3-Steg-Bodenplatten (600 mm; 24")	●	
3-Steg-Bodenplatten (700 mm; 28")		●
3-Steg-Bodenplatten (800 mm; 32")		●
3-Steg-Bodenplatten - H / Chassis (600 mm; 24")		●
Laufrollenschutz	●	
Komplette Laufrollenschutz		●

STD = Standard
OPT = Optional

- * Standard- und Wahlausstattung können je nach Modell abweichen. Weitere Informationen erhalten Sie von Ihrem Hyundai-Händler. Die Maschinenausstattung kann von internationalen Normen abhängig sein.
- * Auf den Fotos können Anbauten und optionale Geräte abgebildet sein, die in Ihrer Region nicht erhältlich sind.
- * Änderungen der Materialien und technischen Daten vorbehalten.
- * Alle Maße in angloamerikanischen Maßeinheiten sind auf das nächste volle Maß (Pound oder Zoll) gerundet.
- * Die Klimaanlage in dieser Maschine enthält als Kältemittel das fluoridierte Treibhausgas HFC-134a (Treibhauspotenzial = 1430). Das System enthält 0,65 kg Kältemittel, was einem CO₂-Äquivalent von 0,9295 metrischen Tonnen entspricht.

 **HYUNDAI CONSTRUCTION EQUIPMENT**

BITTE KONTAKTIEREN SIE

Hyundai Construction Equipment Europe nv

Hyundailaan 4, 3980 Tessenderlo, Belgium **Tel:** (32) 14-56-2200 **Fax:** (32) 14-59-3405

www.hyundai.eu

DE - 2017.11 Rev 5